

Frost-Proof Wall Hydrant Installation, Use & Repair Guide

420 Anti-Siphon Series

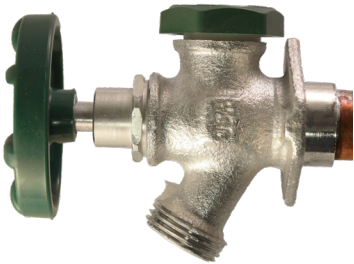

See Pages 4-5

450 Standard Series

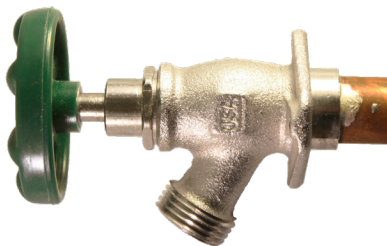

See Pages 6-7

460 Arrow-Breaker® Series

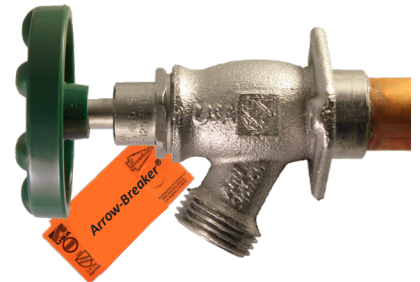

See Pages 8-9

470 Freeze-Proof® Series

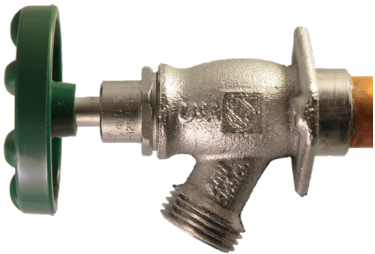

See Pages 10-11

480 Self-Draining Series

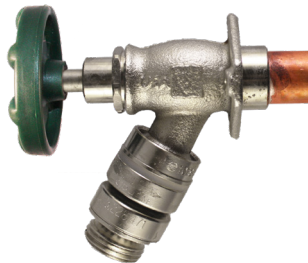

See Pages 12-13

490 Hot & Cold Series



See Pages 14-15

455BFP "Apache" Series

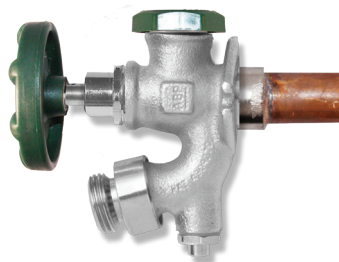

See Pages 17-18

Frost-Proof Model # Identification:

4 5 6 - 0 4 L F

Frost-Proof Wall Hydrants (first digit "4")









Hydrant Series:
See following pages
for information

LEAD FREE

All Frost-Proof Hydrants are
ANSI/NSF 372 certified by
IAPMO Laboratories

Hydrant Length:
Wall Thickness Available in
02", 04", 06", 08", 10", 12", & 14"
(See diagram below for more details)

INLET CONNECTION TYPES:

0	Plain End for Push-Fit Coupling (470 Series Only)		1/2"
1	3/4" Wirsbo Uponor Style Pex		1.7"
2	1/2" Wirsbo Uponor Style Pex		1.6"
5	Dual Connections: 1/2" Female Pipe Thread ID. 3/4" Male Pipe Thread OD.		1.75"
6	Dual Connections 1/2" Copper Sweat ID. 1/2" Male Pipe Thread OD.		1.75"
7	3/4" PEX (Crimp Type)		1.4"
8	Dual Connections: 3/4" Copper Sweat ID. 3/4" Male Pipe Thread OD.		1.8"
9	1/2" PEX (Crimp Type)		1.4"

Rough-In Dimensions

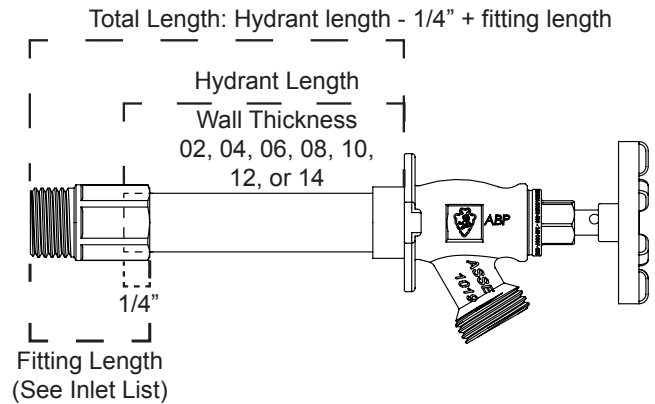

How to Measure a Frost-Proof Stem:

- 1- Identify the model of frost-proof hydrant installed.
- 2- Measure overall (tip to tip) length of the stem assembly.



- 3- Subtract 4" & add to PK #:
 - I.e. 8" - 4" = 4": PK2004
 - 420 Series hydrant with 4" wall depth.

Frost-Proof Wall Hydrant Installation and Use

- Frost-proof wall hydrants are designed to prevent damage from freezing water in plumbing systems. Frost-proof wall hydrants protect the water supply from the cold weather by shutting-off flow at the heated space inside wall.
- For a frost-proof wall hydrant to work properly, it must be installed at a slight downward angle toward the spout (as pictured right). This allows water to drain when it is shut-off. A gap spacer wedge can be used to ensure proper installation with a downward tilt.
- If the hydrant is installed level or at an upward angle, water will not drain properly and may lead to freeze damage.

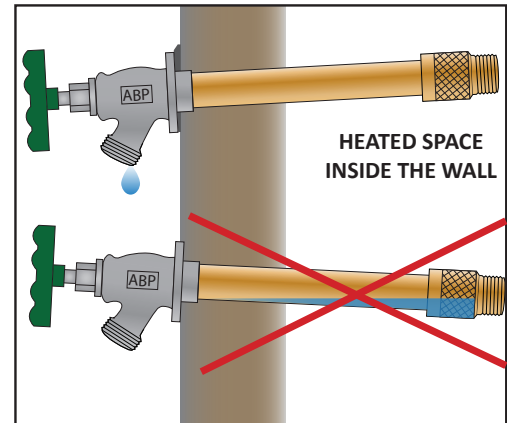

The only cause of a burst frost-proof hydrant is water expansion from freezing water inside an un-drained wall hydrant. Properly installed valves (with downward tilt) will always drain unless a hose or other device was left attached.



Grey gap spacer wedge can be used to ensure downward tilt.
 "REMOVE HOSE IN FREEZING WEATHER".

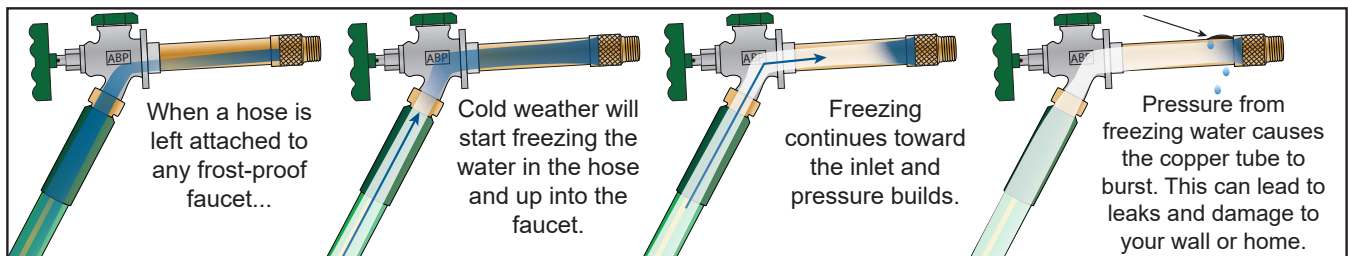

When a hose or other device is left attached to the faucet (such as an irrigation timer, "y" hose splitter, or add-on back-flow preventer), water will remain trapped inside the wall hydrant. If cold weather hits, water inside the hose will begin to freeze upward toward the back, or "seat", of the faucet, and the pressure inside the copper tubing will exceed capacity and burst. This will cause leaks within the wall and can cause considerable damage. Frost-proof wall hydrants are designed to prevent this damage as long as the user ensures the faucets are angled downward and all hoses/devices are removed during freezing weather.

420 Series Anti-Siphon Wall Hydrants

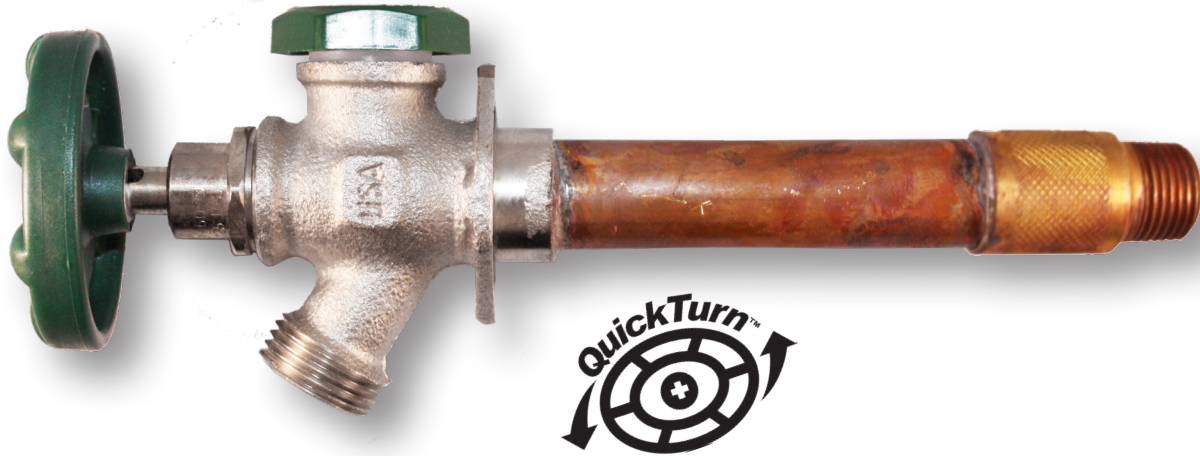

420 Series Hydrant Information

- Frost-Free Hydrants with built-in anti-siphon technology.
- Protects drinking water from harmful contaminants (pesticides, herbicides, etc).
- Includes QuickTurn® Technology: easy on/off operation without letting go of the handle.
- ASSE 1019 Certified by IAPMO.
- 3-Year Limited Warranty.
- **Faucet should not be pressurized (left open) for more than 12 consecutive hours.**
- **Not designed for constant pressure applications (i.e. sprinkler & drip timers, “Y” Shut-offs).**
- When using self-closing nozzle, always relieve pressure after shut-off.
- Faucet must be installed at a downward angle to ensure drainage & prevent freezing.

Repair

Leaking out of the Weep Hole during use:

- Cause: worn out o-ring on the check assembly. This happens over time or if the faucet is left “ON” for long periods of time (over 12 hrs).
- If the faucet was installed after 1999 OR the stem’s check assembly is SPRING-LESS, replace with new check assembly [PK2016] OR full stem.

Leaking out of the Green Cap Air-Vent:

- Cause: worn, broken or missing parts.
- Repair by removing old parts & replacing with new parts from kit [PK1430].
- Follow assembly diagram on next page.

Any Leaking on Faucet Installed Before 1999 or Check Assembly with SPRING

- Cause: worn out parts & seals.
- If the stem has a SPRING in the Check Assembly, the full stem should be replaced with a Special Order Stem Length that is 1/4” longer [PK2004SP - PK2014SP]- OR replace the hydrant.

Leaking out of the Hose Thread when “OFF”- Will Not Shut Off:

- Cause: worn out washer or broken faucet seat.
- Replace the check-assembly or entire stem.
- If replacement parts do not work, contact Champion-Arrowhead.

420 Series Anti-Siphon Wall Hydrants

Repair & Replacement Parts

AIR-VENT ASSEMBLY	RUBBER-COATED HANDLE & SCREW	SPRING-LESS CHECK ASSEMBLY	GAP-SPACER WEDGE	420 SERIES 4" STEM ASSEMBLY	420 SERIES 6" STEM ASSEMBLY	420 SERIES 8" STEM ASSEMBLY
# PK1430 Includes green cap, housing, plunger, & O-ring (#s 7-10)	# PK1295 Rubber-coated green oval handle (# 2) & stainless screw (# 1)	# PK2016 Replacement spring-less check assembly (# 6)	# PK1450 Replacement gap spacer, used to tilt faucet downward	# PK2004 4-inch hydrant stem assembly (# 3-6) (8" total length)	# PK2006 6-inch hydrant stem assembly (# 3-6) (10" total length)	# PK2008 8-inch hydrant stem assembly (# 3-6) (12" total length)
420 SERIES 10" STEM ASSEMBLY	420 SERIES 12" STEM ASSEMBLY	420 SERIES 14" STEM ASSEMBLY				
# PK2010 10-inch hydrant stem assembly (# 3-6) (14" total length)	# PK2012 12-inch hydrant stem assembly (# 3-6) (16" total length)	# PK2014 14-inch hydrant stem assembly (# 3-6) (18" total length)				

How to measure a frost-proof stem:

- 1- Measure overall (tip to tip) length of the stem assembly, with the check assembly pushed in.
- 2- Subtract 4".

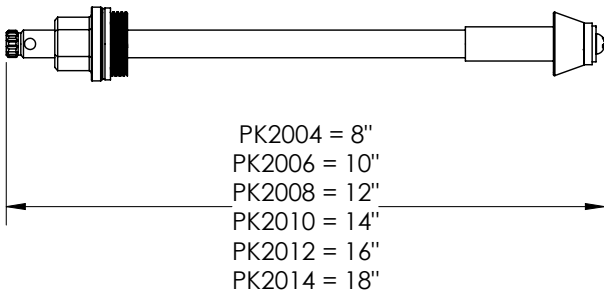

*For 420 series hydrants installed prior to 1999, use PK20__SP stem assembly to replace old style stems that have a spring check assembly.
Contact Arrowhead Brass for more details

If your faucet stem has a SPRING or does NOT measure to an even length, you need an "SP" Stem

- SP stems are 4-1/4" longer than the hydrant length (i.e. PK2004SP = 8-1/4").
- SP stems are designed for valves older than 1999. SP stems are non-returnable & not covered under warranty.

450 Series Standard Frost-Proof Wall Hydrants

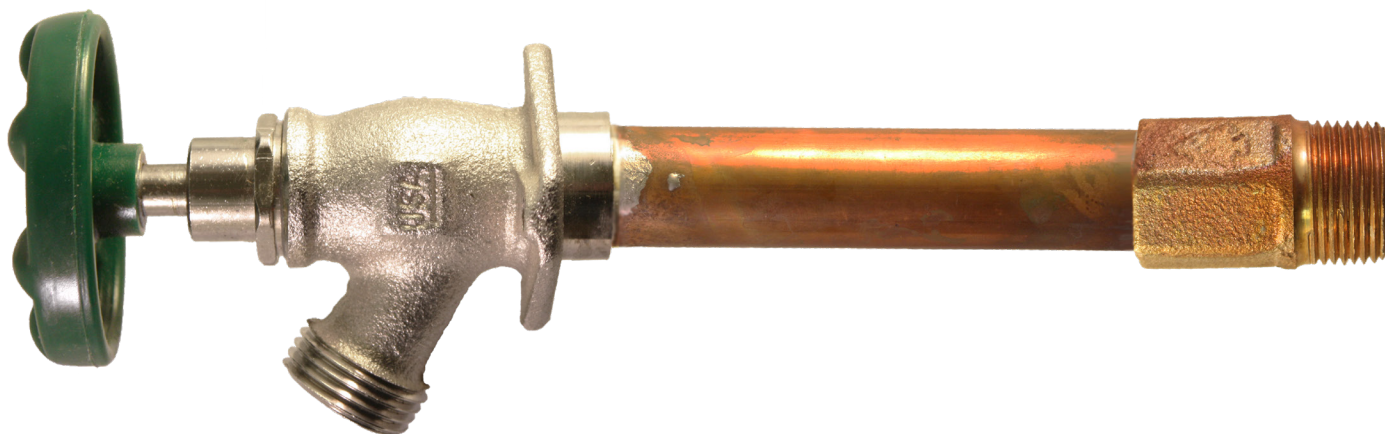

450 Series Hydrant Information

- Standard Frost-Free Wall Hydrant.
- Protect faucet & pipes from freezing & damage by separating cold weather from water supply.
- Made in the USA; 3-Year Limited Warranty.
- **IMPORTANT: Always shut off faucet after use AND remove hose in order to drain the faucet and prevent freezing.**
- Does not provide anti-siphon back-flow protection; add-on devices available (may be required by code).
- Faucet must be installed at a downward angle to ensure drainage & prevent freezing.
- When using self-closing nozzle, always relieve pressure after shut-off.

Repair

Leaking out of the hose thread when “OFF”

- Faucet will not shut off, has constant leak.
- Cause: worn out washer or broken faucet seat.
- Replace seat washer & screw at end of the stem [PK1000] or replace entire stem assembly [PK8004 - PK8014].
- If new stem does not stop leak, the seat is damaged and the faucet will need to be replaced.
- If original stem is not a standard length [1/4” longer than even inch lengths], replace with PK80__SP.

Leaking out of the packing nut or bonnet:

- Cause: loose bonnet or worn out seals in the bonnet.
- Replace stem assembly with PK80__, measure tip to tip of the existing hydrant stem and subtract 4”.
- If original stem is not a standard length [1/4” longer than even inch lengths], replace with PK80__SP.

450 Series Standard Frost-Proof Wall Hydrants

Repair & Replacement Parts

STEM REBUILD KIT	GREEN OVAL HANDLE & SCREW	GAP-SPACER WEDGE	450 SERIES 4" STEM ASSEMBLY	450 SERIES 6" STEM ASSEMBLY	450 SERIES 8" STEM ASSEMBLY	450 SERIES 10" STEM ASSEMBLY
# PK1000 Seat washer (# 6) & screw (# 7), nylon washer (# 4) & handle screw (# 1)	# PK1295 Green oval handle (# 2) & stainless screw (# 1)	# PK1450 Replacement gap spacer, used to tilt faucet downward	# PK8004 4-inch hydrant stem assembly (#'s 3-7) (8" total length)	# PK8006 6-inch hydrant stem assembly (#'s 3-7) (10" total length)	# PK8008 8-inch hydrant stem assembly (#'s 3-7) (12" total length)	# PK8010 10-inch hydrant stem assembly (#'s 3-7) (14" total length)
450 SERIES 12" STEM ASSEMBLY	450 SERIES 14" STEM ASSEMBLY					
# PK8012 12-inch hydrant stem assembly (#'s 3-7) (16" total length)	# PK8014 14-inch hydrant stem assembly (#'s 3-7) (18" total length)					

How to measure a frost-proof stem:

- 1- Measure overall (tip to tip) length of the stem assembly.
- 2- Subtract 4".

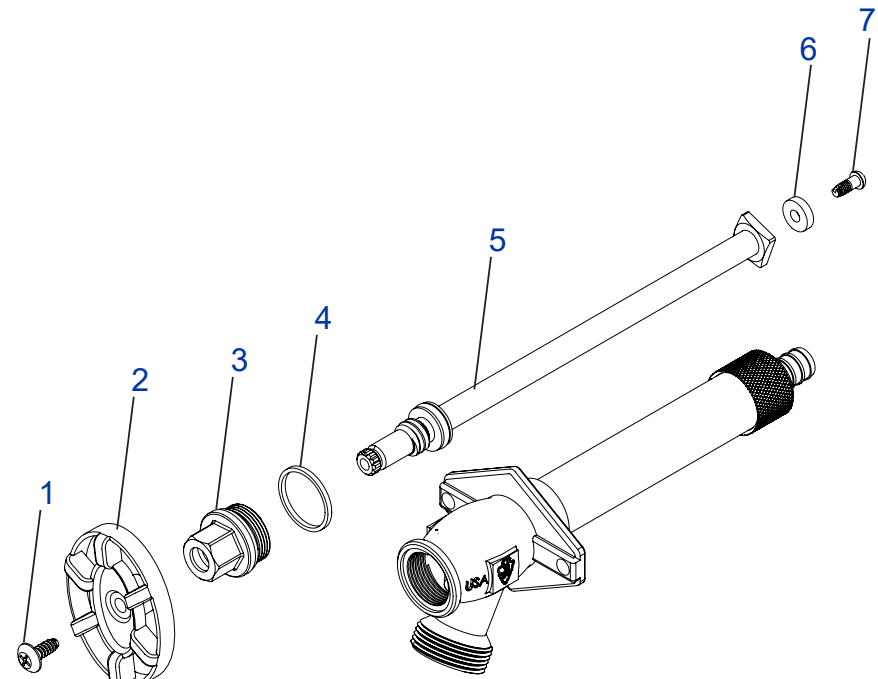
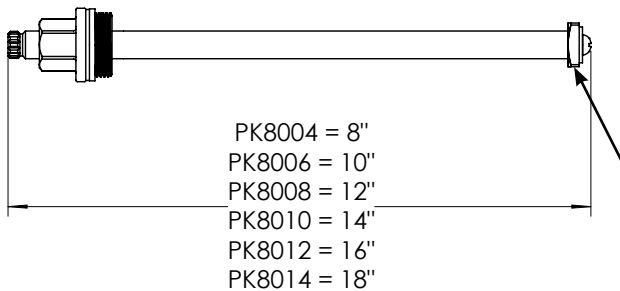

On faucets older than 1999: replacement stems may require a trim to the brass square washer retainer. Use a file or grinder to trim 1/16" off each corner to fit the stem into faucet. Contact Champion-Arrowhead for more information.

If the original stem is not an even length from tip to tip (8", 10", 12", 14", 16" or 18"), and is 1/4" longer, you likely will need an "SP" stem: PK80__SP.

460 Series Arrow-Breaker® Frost-Proof Wall Hydrants

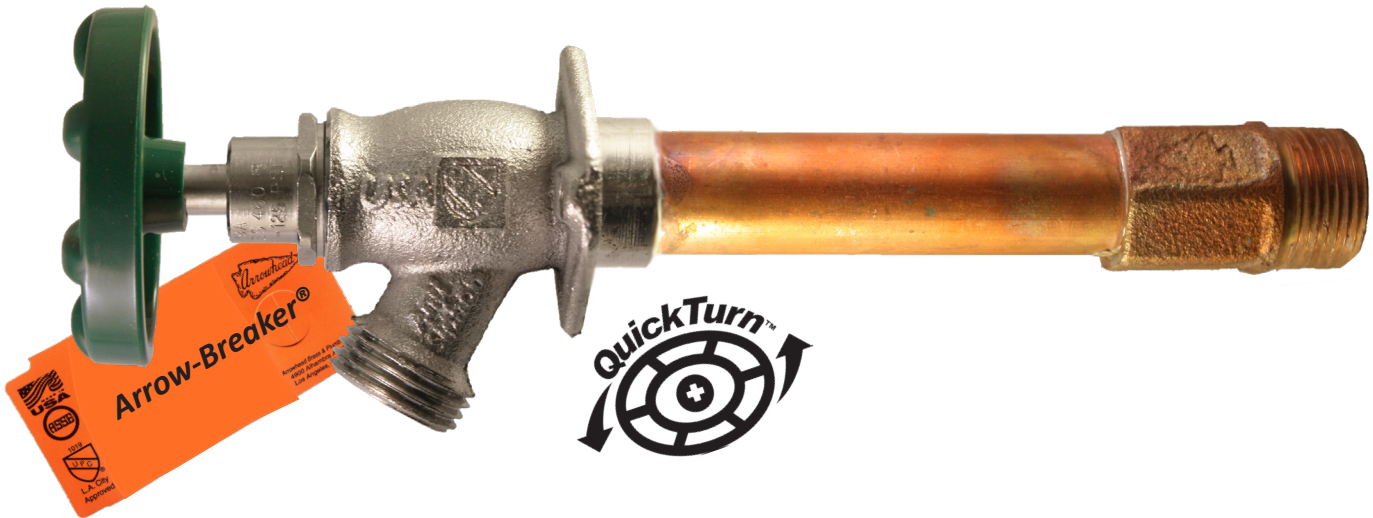

460 Series Hydrant Information

- Arrow-Breaker® Frost-Free Hydrants with built-in anti-siphon technology.
- Protects drinking water from harmful contaminants (pesticides, herbicides, etc).
- Includes QuickTurn® Technology: easy on/off operation without letting go of the handle.
- Protects pipes from freezing & damage.
- ASSE 1019 Listed; IAPMO Certified.
- Made in the USA; 3-Year Limited Warranty.
- **Faucet should not be pressurized (left open) for more than 12 consecutive hours.**
- **Not designed for constant pressure applications (i.e. sprinkler & drip timers, “Y” Shut-offs).**
- When using self-closing nozzle, always relieve pressure after shut-off.
- Faucet must be installed at a downward angle to ensure drainage & prevent freezing.

Repair

Leaking out of the Hose Thread when “OFF”:

- Cause: worn out washer or broken faucet seat.
- Repair by replacing the Spring-Less Check Assembly (PK6026) or replacing the entire stem assembly (PK6004-PK6014).
- If faucet continues to leak when OFF, the faucet seat might be broken and the faucet will need to be replaced.

Leaking out of the Weep Hole during use:

- Cause: worn out o-ring on the check assembly. This happens over time or if the faucet is left “ON” for long periods of time (over 12 hrs).
- Repair by replacing the Spring-Less Check Assembly (PK6026).
- If the leak still occurs, replace the entire stem assembly (PK6004-PK6014).

Leaking out of the Packing Nut or Bonnet:

- Cause: loose bonnet or worn out seals in the bonnet.
- If tightening the bonnet does not stop leaking from the threads, replace nylon washer (or the Stem Assembly (PK6004-PK6014).

460 Series Arrow-Breaker® Frost-Proof Wall Hydrants

Repair & Replacement Parts

RUBBER-COATED HANDLE & SCREW	SPRING-LESS CHECK ASSEMBLY	GAP-SPACER WEDGE	460 SERIES 4" STEM ASSEMBLY	460 SERIES 6" STEM ASSEMBLY	460 SERIES 8" STEM ASSEMBLY	460 SERIES 10" STEM ASSEMBLY
						
# PK1295 Rubber-coated green oval handle (# 2) & stainless screw (# 1)	# PK6026 Replacement spring-less check assembly (# 6)	# PK1450 Replacement gap spacer, used to tilt faucet downward	# PK6004 4-inch hydrant stem assembly (# 3-6) (8" total length)	# PK6006 6-inch hydrant stem assembly (# 3-6) (10" total length)	# PK6008 8-inch hydrant stem assembly (# 3-6) (12" total length)	# PK6010 10-inch hydrant stem assembly (# 3-6) (14" total length)

460 SERIES 12" STEM ASSEMBLY	460 SERIES 14" STEM ASSEMBLY
	
# PK6012 12-inch hydrant stem assembly (# 3-6) (16" total length)	# PK6014 14-inch hydrant stem assembly (# 3-6) (18" total length)

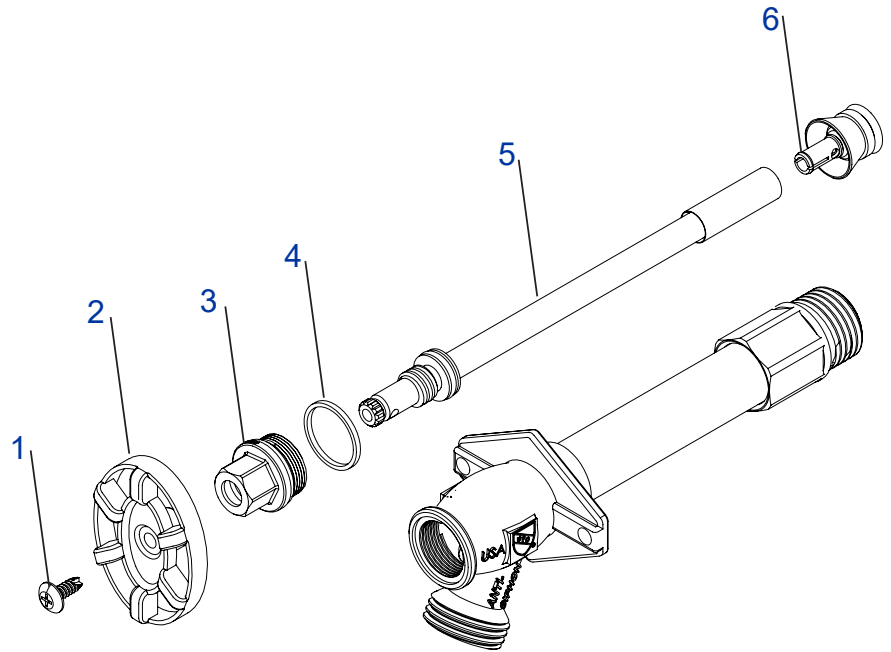

How to measure a frost-proof stem:

- 1- Measure overall (tip to tip) length of the stem assembly, with the check assembly pushed in.
- 2- Subtract 4".

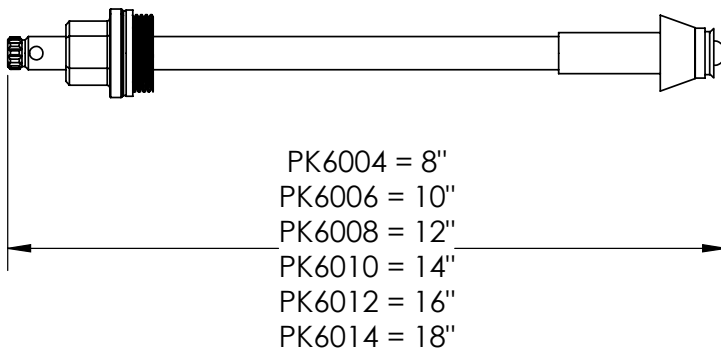

470 Series Freeze-Proof® Wall Hydrants



470 Series Hydrant Information

- Freeze-Proof® technology prevents damage from freezing water by reducing pressure build-up.
- O-ring shut off design that prevents damage & wear to hydrant seat.
- Maintains constant separation between household and irrigation water sources.
- Prevents back-flow by utilizing patented Arrow-Breaker® integrated anti-siphon technology.
- QuickTurn® easy on/off operation without letting go of the handle.
- ASSE 1019-A Certified.
- Max. 140°F – 125 PSI.
- 3 Year limited warranty; Made in the USA from domestic and foreign components.
- **Faucet should not be pressurized (left open) for more than 12 consecutive hours.**
- **Not designed for constant pressure applications (i.e. sprinkler & drip timers, “Y” Shut-offs).**
- Remove hose after use to drain faucet.
- When using self-closing nozzle, always relieve pressure after shut-off.
- Faucet must be installed at a downward angle to ensure drainage & prevent freezing.

Repair

Leaking or malfunction:

- Shut-off water to the hydrant & open it all the way.
- Loosen the bonnet with a wrench and remove stem assembly.
- With the stem removed, briefly turn water supply back on to flush the hydrant, then shut-off again.
- Inspect the stem for cracks or damage to the O-rings or other parts. The recommended repair is to replace the Freeze-Proof® check assembly [PK7026] or replace the entire stem. Read instructions on next page to identify the stem part kit needed [i.e. PK7004 - PK7014].
- Reinstall stem with bonnet in the open position, close the hydrant and turn water back on to the valve.

470 Series Freeze-Proof® Wall Hydrants

Repair & Replacement Parts

RUBBER-COATED HANDLE & SCREW	FREEZE-PROOF® CHECK ASSEMBLY	GAP-SPACER WEDGE	470 SERIES 4" STEM ASSEMBLY	470 SERIES 6" STEM ASSEMBLY	470 SERIES 8" STEM ASSEMBLY	470 SERIES 10" STEM ASSEMBLY
# PK1297 Rubber-coated green oval handle (# 2) & stainless screw (# 1)	# PK7026 Replacement Freeze-Proof® check assembly (# 6)	# PK1450 Replacement gap spacer, used to tilt faucet downward	# PK7004 4-inch hydrant stem assembly (# 3-6) (8" total length)	# PK7006 6-inch hydrant stem assembly (# 3-6) (10" total length)	# PK7008 8-inch hydrant stem assembly (# 3-6) (12" total length)	# PK7010 10-inch hydrant stem assembly (# 3-6) (14" total length)
470 SERIES 12" STEM ASSEMBLY	470 SERIES 14" STEM ASSEMBLY					
# PK7012 12-inch hydrant stem assembly (# 3-6) (16" total length)	# PK7014 14-inch hydrant stem assembly (# 3-6) (18" total length)					

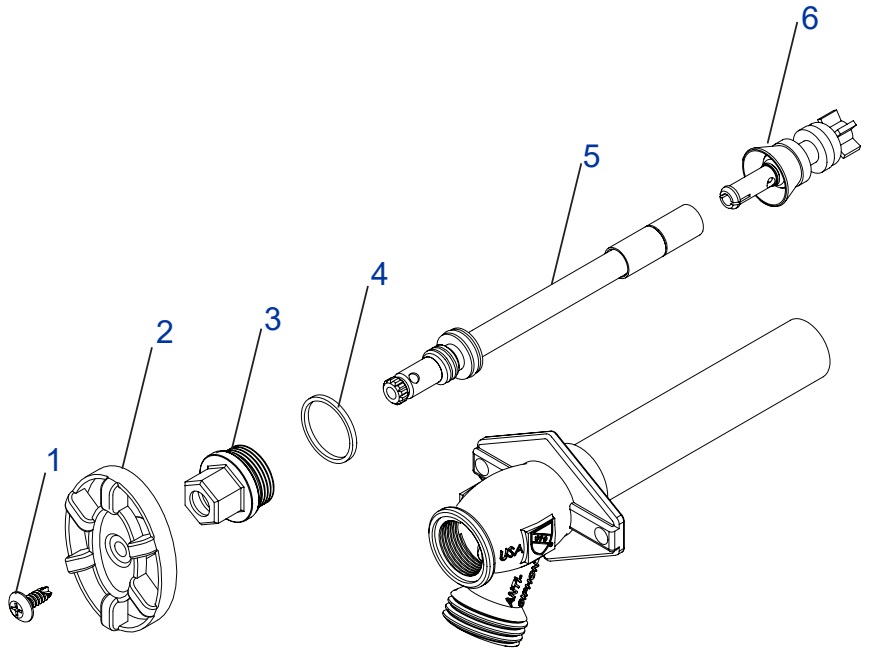

How to measure a frost-proof stem:

- 1- Measure overall (tip to tip) length of the stem assembly.
- 2- Subtract 3.75".

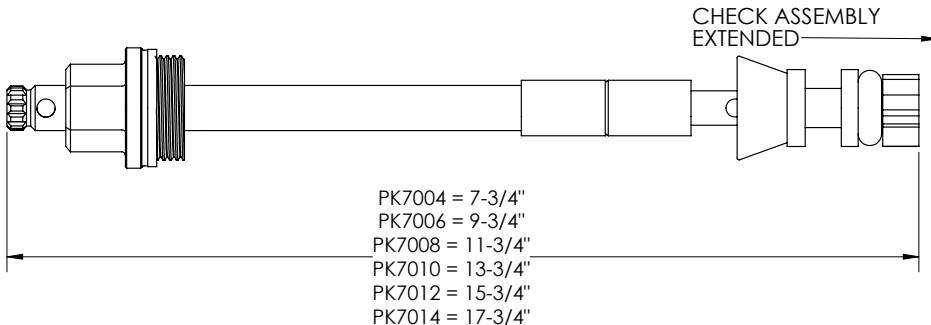

480 Series Self-Draining Anti-Siphon Wall Hydrants

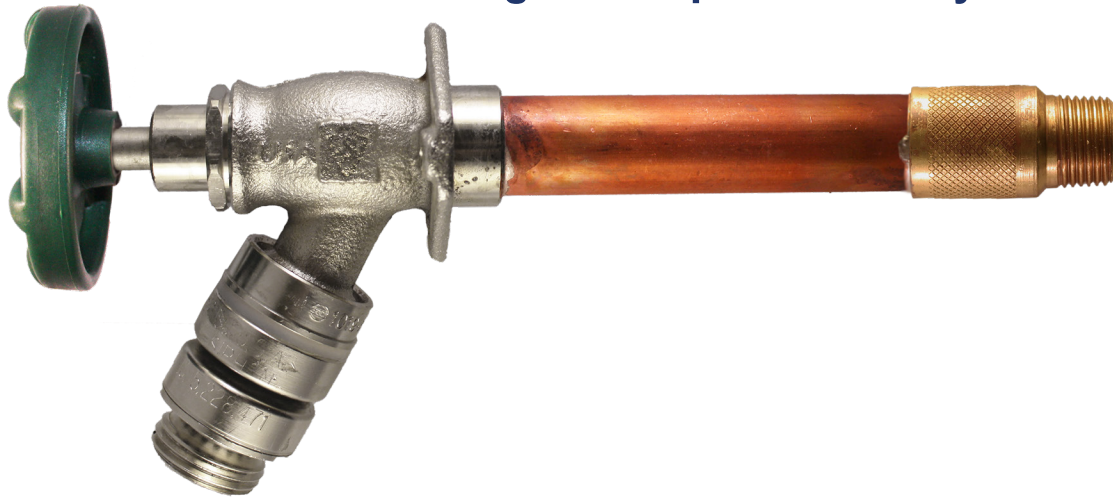

480 Series Hydrant Information

- Frost-Free Hydrants with Self-Draining Anti-Siphon Vacuum Breaker.
- Protects drinking water from harmful contaminants (pesticides, herbicides, etc).
- Drains water from hydrant upon shut off to protect faucet & pipes from freezing & damage.
- ASSE 1019 Listed; IAPMO Certified.
- Made in the USA; 3-Year Limited Warranty.
- **Faucet should not be pressurized (left open) for more than 12 consecutive hours.**
- **Not designed for constant pressure applications (i.e. sprinkler & drip timers, “Y” Shut-offs).**
- When using self-closing nozzle, always relieve pressure after shut-off.
- Faucet must be installed at a downward angle to ensure drainage & prevent freezing.

Repair

Leaking out of the hose thread when “OFF”

- Faucet will not shut off, has constant leak.
- Cause: worn out washer or broken faucet seat.
- Replace seat washer & screw at end of the stem [PK1000] or replace entire stem assembly [PK8004 - PK8014].
- If new stem does not stop leak, the seat is damaged and the faucet will need to be replaced.
- If original stem is not a standard length [1/4” longer than even inch lengths], replace with PK80__SP.

Leaking out of the packing nut or bonnet:











- Cause: loose bonnet or worn out seals in the bonnet.
- Replace stem assembly with PK80__, measure tip to tip of the existing hydrant stem and subtract 4”.
- If original stem is not a standard length [1/4” longer than even inch lengths], replace with PK80__SP.

Problem with the Self-Draining Vacuum Breaker? See Page 16



480 Series Self-Draining Anti-Siphon Wall Hydrants

Repair & Replacement Parts

STEM REBUILD KIT	RUBBER-COATED HANDLE & SCREW	SELF-DRAINING VACUUM BREAKER	GAP-SPACER WEDGE	480 SERIES 4" STEM ASSEMBLY	480 SERIES 6" STEM ASSEMBLY	480 SERIES 8" STEM ASSEMBLY
						
# PK1000 Seat washer (# 6) & screw (# 7), nylon washer (# 4) & handle screw (# 1)	# PK1295 Rubber-coated green oval handle (# 2) & stainless screw (# 1)	# PK1390 Self-draining vacuum breaker- fine threads (# 8)	# PK1450 Replacement gap spacer, used to tilt faucet downward	# PK8004 4-inch hydrant stem assembly (# 3-7) (8" total length)	# PK8006 6-inch hydrant stem assembly (# 3-7) (10" total length)	# PK8008 8-inch hydrant stem assembly (# 3-7) (12" total length)
480 SERIES 10" STEM ASSEMBLY	480 SERIES 12" STEM ASSEMBLY	480 SERIES 14" STEM ASSEMBLY				
						
# PK8010 10-inch hydrant stem assembly (# 3-7) (14" total length)	# PK8012 12-inch hydrant stem assembly (# 3-7) (16" total length)	# PK8014 14-inch hydrant stem assembly (# 3-7) (18" total length)				

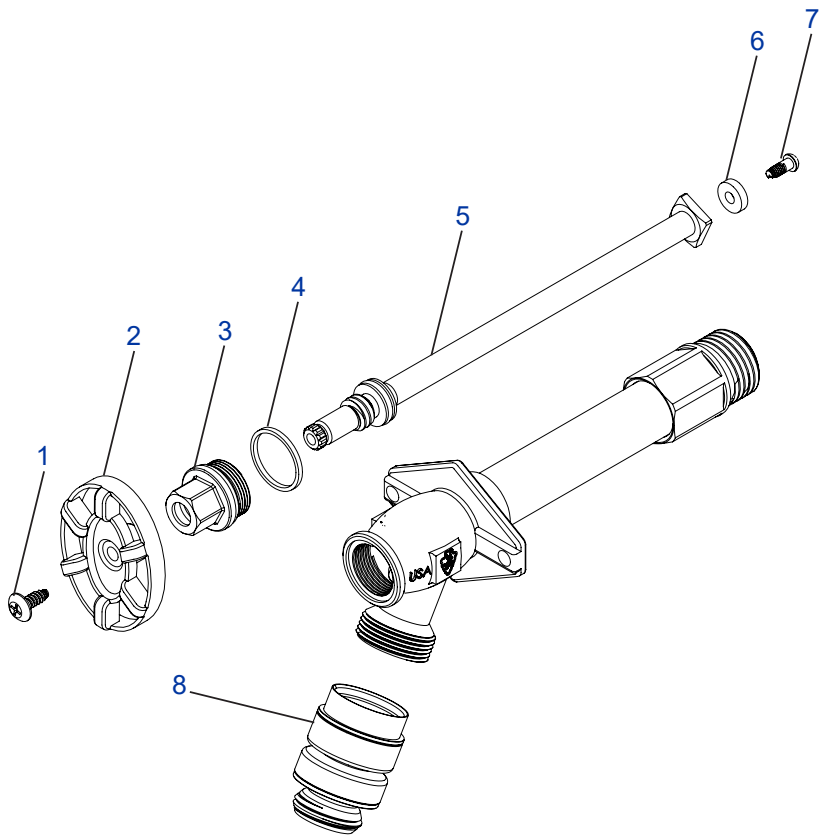

How to measure a frost-proof stem:

- 1- Measure overall (tip to tip) length of the stem assembly.
- 2- Subtract 4".

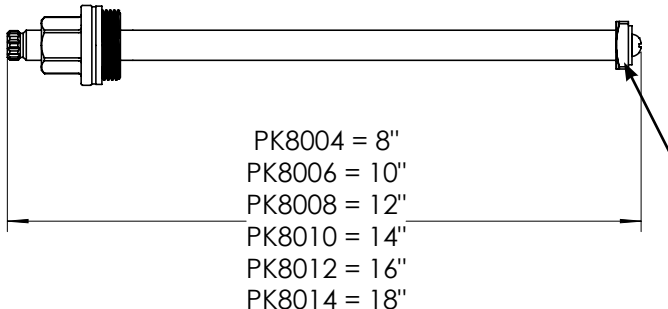

On faucets older than 1999: replacement stems may require a trim to the brass square washer retainer. Use a file or grinder to trim 1/16" off each corner to fit the stem into faucet. Contact Arrowhead for more information.

If the original stem is not an even length from tip to tip (8", 10", 12", 14", 16" or 18"), and is 1/4" longer, you likely will need an "SP" stem: PK80__SP.

490 Series Hot & Cold Anti-Siphon Wall Hydrants

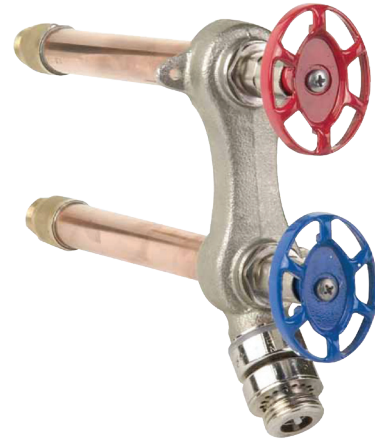

490 Series Hydrant Information

- Heavy pattern Lead-Free brass: NSF/ANSI 372 certified Lead Free, IAPMO listed.
- Hot & Cold Mixing, with color coded red & blue handles.
- External self-draining vacuum breaker: Drains hydrant upon shutoff to prevent freezing.
- ASSE 1019-A approved, IAPMO certified.
- Exclusive O-Ring Bonnet & Stem design.
- **Faucet should not be pressurized (left open) for more than 12 consecutive hours.**
- **Not designed for constant pressure applications (i.e. sprinkler & drip timers, "Y" Shut-offs).**
- Includes QuickTurn® style operation: Easy on/off without letting go of the handle.
- Available in 4, 6, 8, 10, 12 & 14 Inch lengths (other lengths available by special order).

Repair

Leaking out of the Hose Thread when "OFF":

- Cause: worn out washer or broken faucet seat.
- Repair by replacing the stem assembly.
- If faucet continues to leak when OFF, the faucet seat might be broken and the faucet will need to be replaced.

Leaking out of the Vacuum Breaker:

- Cause: worn out gasket and seals; happens with age & use, or when left on/open for long periods of time.
- Fix by replacing fine thread vacuum breaker: 59BFPCHR or PK1390.
- Ensure all 3 brass sections of vacuum breaker are removed.
- Use liquid thread sealant.

Problem with the Self-Draining Vacuum Breaker? See Page 16



490 Series Hot & Cold Anti-Siphon Wall Hydrants

Repair & Replacement Parts

STEM REBUILD KIT 	RED & BLUE HANDLES & SCREWS 	SELF-DRAINING VACUUM BREAKER 	490 SERIES 4" STEM ASSEMBLY 	490 SERIES 6" STEM ASSEMBLY 	490 SERIES 8" STEM ASSEMBLY 	490 SERIES 10" STEM ASSEMBLY
# PK1000 Seat washer (# 1) & screw (# 2), nylon washer (# 4) & handle screw (# 7)	# PK1299 Red & blue oval handles (# 6) & stainless screws (# 7)	# PK1390 Self-draining vacuum breaker- fine threads; PK-retail package (# 8)	# PK9004 4-inch hydrant stem assembly (#'s 1-5) (7-1/4" total length)	# PK9006 6-inch hydrant stem assembly (#'s 1-5) (9-1/4" total length)	# PK9008 8-inch hydrant stem assembly (#'s 1-5) (11-1/4" total length)	# PK9010 10-inch hydrant stem assembly (#'s 1-5) (13-1/4" total length)
490 SERIES 12" STEM ASSEMBLY 	490 SERIES 14" STEM ASSEMBLY 					
# PK9012 12-inch hydrant stem assembly (#'s 1-5) (15-1/4" total length)	# PK9014 14-inch hydrant stem assembly (#'s 1-5) (17-1/4" total length)					

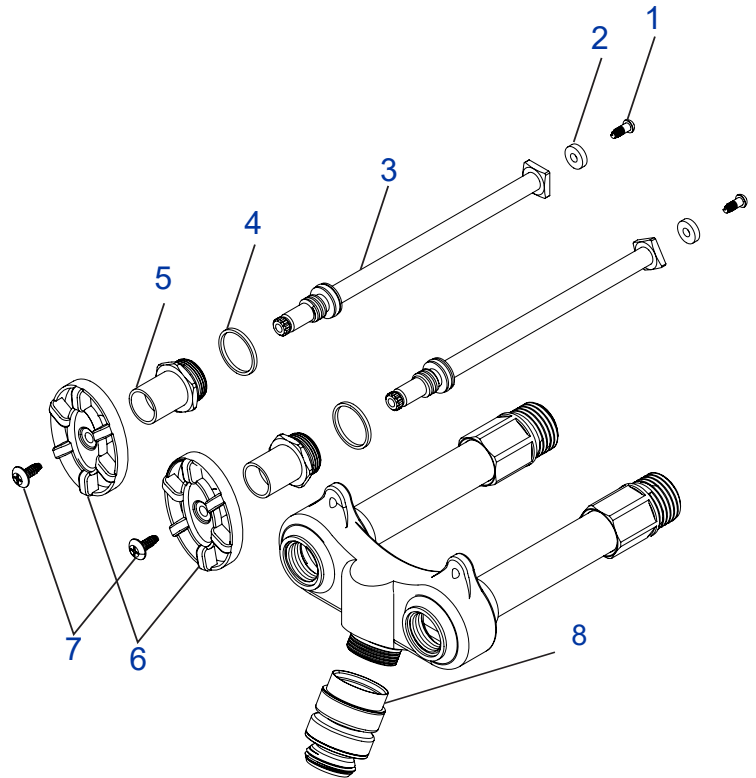

How to measure a frost-proof stem:

- 1- Measure overall (tip to tip) length of the stem assembly.
- 2- Subtract 3.25".

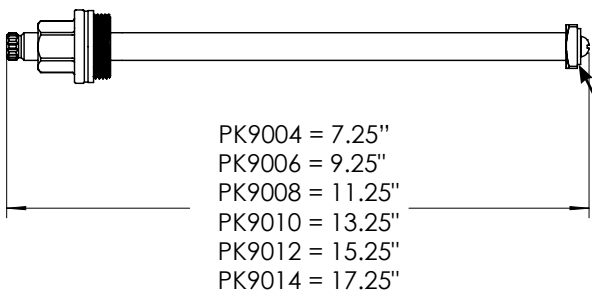

Some hot and cold hydrants may have a "springless check assembly" at the end [similar to the 420 hydrants on pages 6-7]. The PK90__ stems will work as a replacement.

On vertical hydrants, if your stem length does not match the dimensions stated left, contact Champion-Arrowhead customer service for assistance.

Self-Draining Vacuum Breakers [PK1390]

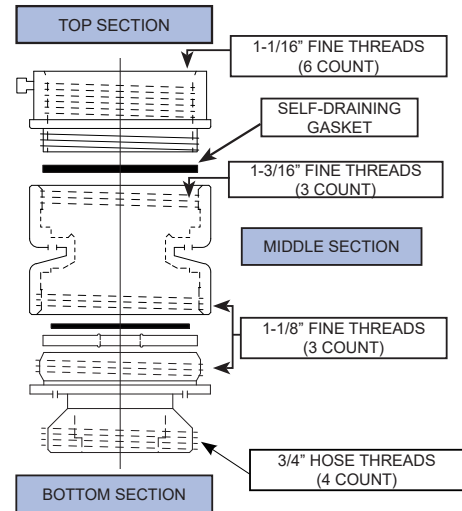

Self-Draining Vacuum Breaker Information

- ASSE 1019 back flow preventer.
- Protects drinking water from harmful contaminants (pesticides, herbicides, etc).
- Designed to drain the faucet upon shut off to prevent damage from freezing.
- **Vacuum Breaker should not be pressurized (left open) for more than 12 consecutive hours.**
- **Not designed for constant pressure applications (i.e. sprinkler & drip timers, “Y” Shut-offs).**
- **When using self-closing nozzle, always relieve pressure after shut-off.**
- **Faucet must be installed at a downward angle to ensure drainage & prevent freezing.**
- Water from wall hydrant will drain in a steady gentle stream for approximately 15-20 seconds after hydrant is turned off.
- For optimum freeze protection, vacuum breaker should be installed at an angle towards the ground, **device will not work if it is installed completely vertical or horizontal.**

Vacuum Breaker Replacements

- Cause: worn out gasket and seals; happens with age & use, or when left on/open for long periods of time.
- Result: Leaks non-stop when on out of holes in “middle Section.
- Fix by replacing fine thread vacuum breaker.
- **TOP SECTION MUST BE REMOVED FROM FAUCET:** Ensure the fine thread top section of the original vacuum breaker is removed from the faucet before trying to install replacement. 6 fine threads should be visible. Hold the faucet body in place with channel locks while removing vacuum breaker (with pipe wrench or vise grips) to prevent damage to faucet.
- Use Liquid Thread Sealant (Pipe Dope) on Fine Threads when installing replacement. Without positive thread seal, vacuum breaker may leak at threads when faucet is in use.
- Set Screw on replacement/new vacuum breakers only. Tighten when installed to prevent removal.

IMPORTANT: After installation, vacuum breaker may need to be pressurized to work correctly: hook up a hose with a closed nozzle attached, turn the faucet on FULL BLAST and allow hose to fill. Once filled, the vacuum breaker will seal & stop leaking.

455BFP Series “Apache” Frost-Proof Wall Hydrants

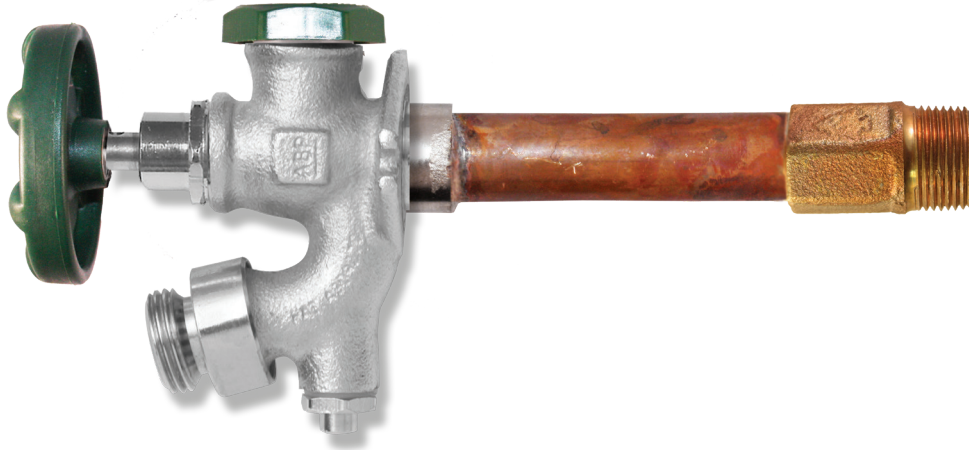

Discontinued 455BFP Series Hydrant Information

- Anti-Siphon Frost-Free Wall Hydrant.
- **455BFP Apache Series- DISCONTINUED IN 2008**; hydrant no longer available.
- **IMPORTANT:** Always shut off faucet after use AND remove hose in order to drain the faucet and prevent freezing.
- Faucet should not be pressurized for more than 12 consecutive hours.
- Not designed for constant pressure applications (i.e. sprinkler & drip timers, “Y” Shut off...).
- When using self-closing nozzle, always relieve pressure after shut-off.

Repair

Leaking out of the hose thread when “OFF” - OR -

Leaking out of the Packing Nut or Bonnet

- Cause: worn out washer, seals or broken faucet seat.
- Replace seat washer & screw at end of the stem [PK1000]. Fill packing nut with .
- If repair parts do not stop leak, replace the faucet.
- **Replacement stems [PK5004-PK5014] are no longer available.**

Leaking out of the Green Cap Air-Vent:

- Cause: worn, broken or missing parts.
- Repair by removing old parts & replacing with new parts from kit [PK1430]
- Follow assembly drawing on next page.
- If leak persists, ensure positive seal and cleaned threads; Do not use thread tape.

Leaking out of the Drain (below hose connection):

- Cause: worn, broken or missing parts.
- Part Kit **PK1440 is no longer available.**
- A replacement wall hydrant is suggested.

Leaking out of the Hose Vacuum Breaker:

- Cause: worn, broken or missing parts.
- Repair by removing old parts & replacing with new parts [PK1370].
- Use thread sealant when installing new part.

455BFP Series “Apache” Frost-Proof Wall Hydrants

Repair & Replacement Parts

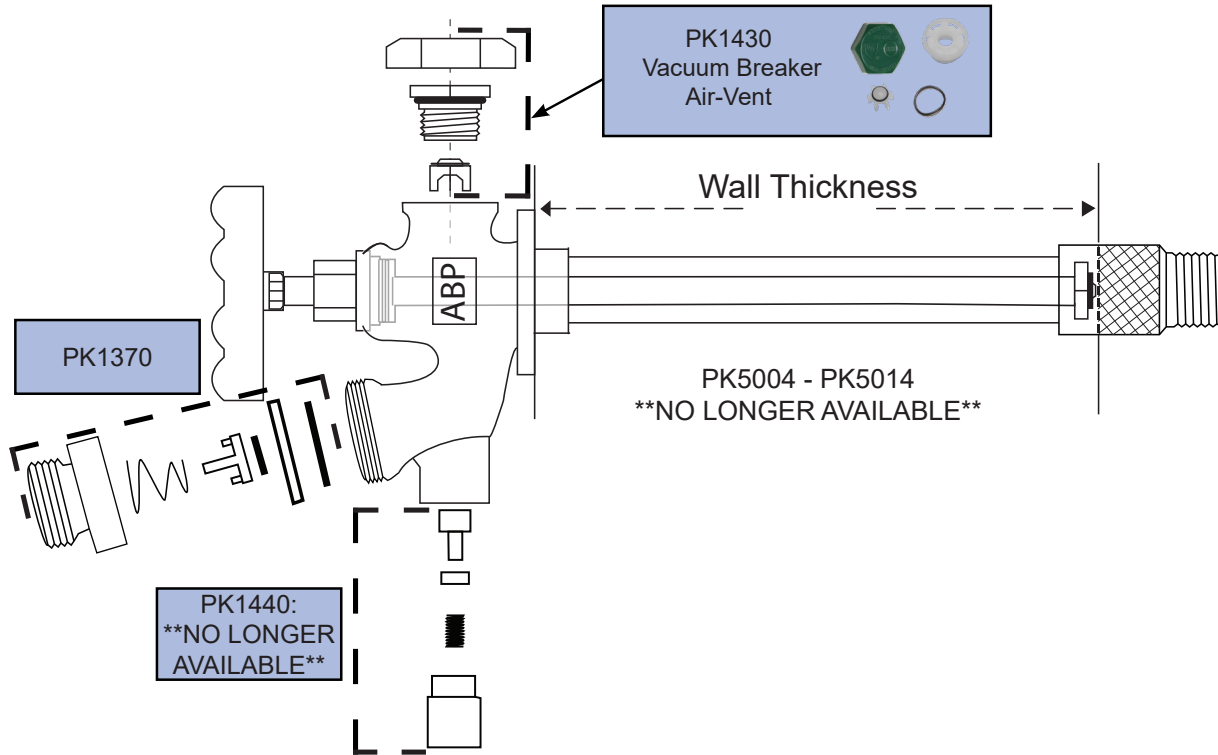

The 455BFP Apache Series has been discontinued since 2008. Many replacement parts are no longer available. If these parts are required, it is suggested that the Apache series hydrants be replaced with a new hydrant model. Available part kits are below.

STEM REBUILD KIT



PK1000
Seat washer & screw, nylon washer & handle screw

GREEN OVAL HANDLE & SCREW



PK1290
Green oval handle & stainless screw

AIR-VENT ASSEMBLY

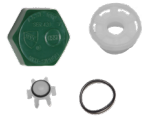

PK1430
Includes green cap, housing, plunger, & O-ring

VACUUM BREAKER



PK1370
Fine thread nickel plated vacuum breaker- PK- retail package