

Curbless Showers

AN INSTALLATION GUIDE

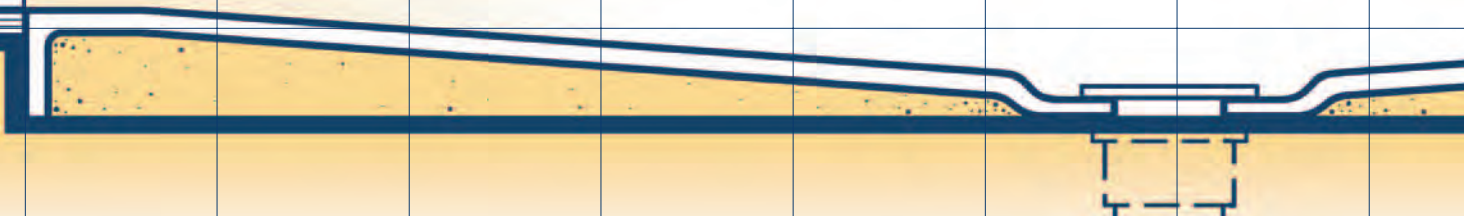

Contents



INTRODUCTION

CONTROLLING WATER 3

Overall Shower Unit Size

Placement of Fixed and Hand-held Showers

FLUSH ENTRANCE 5

Custom-built Showers

Prefabricated Shower Units

ADDITIONAL MEASURES TO CONTROL WATER 10

Shower Curtains and Doors

Secondary Drains

Flexible and Removable Dams



REINFORCING FOR GRAB BARS AND WALL-HUNG SEATS 12



SHOWER PERSPECTIVES 14

Custom-built Shower

Prefabricated Shower

Universal Bathing Area

Credits

AUTHORSHIP: *Leslie C. Young, Rex J. Pace*

**ARCHITECTURAL DESIGN AND
CONCEPTUAL ILLUSTRATIONS:** *Rex J. Pace*

REVIEWERS: *Rick Millard, Richard Duncan*

**GRAPHIC DESIGN AND
PRODUCTION:** *Shravan Rajagopal, Mara C. Whitney*

ILLUSTRATION: *Rex J. Pace, Mara C. Whitney, Robert B. Graham*

CURBLESS SHOWERS: AN INSTALLATION GUIDE

PRODUCED BY

The Center for Universal Design

College of Design, North Carolina State University

FOR THE

North Carolina Department of Health and Human Services

Division of Vocational Rehabilitation Services

©2003 THE CENTER FOR UNIVERSAL DESIGN, College of Design, NC State University
Major funding provided by the National Institute on Disability and Rehabilitation Research,
US Department of Education

Curbless Showers: An Installation Guide

Introduction

i

This booklet is intended to assist architects, builders, remodelers, installers and carpenters better understand the critical design and construction issues involved in installing curbless or “roll-in” showers. The term “curbless” is used throughout this booklet since “roll-in” generally suggests that such a shower is beneficial only to people who use wheelchairs. In fact, curbless showers offer benefits to many people who do not use wheelchairs, and are usable by almost everyone.

Traditionally, many dwellings have had a combination tub/shower bathing unit that gives the user the option of standing to shower or sitting in the bathtub. However, climbing in and out of a bathtub can be difficult and even dangerous for people whose balance, strength, or mobility may be limited. Some people who use a wheelchair find bathtubs and showers unusable. People recuperating from an accident or illness, may suddenly find themselves unable to use a fixture to which they have been accustomed. Others may just become unable to bathe as they once did due to a subtle and gradual loss of mobility, agility, or strength.

*Curbless showers **PROVIDE ENOUGH SPACE** for people in wheelchairs to maneuver and enough space to have an attendant assist if necessary.*

Why

CURBLESS SHOWERS?

Bathrooms are one of the most dangerous rooms in a dwelling due to the hard, slippery-when-wet surfaces. Bathrooms typically have few handholds or other gripping surfaces useful for support. With the growing number of people with disabilities and the aging of our society, we have come to recognize that to be able to bathe safely and independently, people must be given a variety of bathing options. Traditional fixtures often do not meet the variety of individual needs.

A relatively new fixture design, the curbless shower, is extremely versatile and can be considered “universal”. These showers feature a very low or no threshold at all so users may easily walk or roll into the unit. Curbless showers also may have a built-in seat, a hand-held

*Curbless showers can be used to **STAND AND BATHE** in a conventional manner.*



Introduction

ii

shower, and appropriately placed grab bars for support, though can still be used in a traditional manner where the bather stands to shower. The only bathing option that a curbless shower does not offer is the opportunity to soak. However, in many dwellings today there often is a second bathing fixture—which could be a bathtub.

INSTALLATION ISSUES

The designs presented in this booklet meet both the *NC State Accessibility Code* as well as the *ADA Standards for Accessible Design*. In single-family housing, with a few exceptions, bathrooms are not required to meet the design requirements of these documents. However, in occupancies which require a specific number of “fully accessible” units, such as multifamily housing, if curbless showers are installed they must comply with the design requirements.



PORTABLE SEATS can be placed in a curbless shower for walking people who prefer to sit while showering.

Both the *NC State Accessibility Code* and the *ADA Standards for Accessible Design* prohibit thresholds at curbless (or roll-in) showers. Thus, containing water so it does not seep into the subfloor or splash out of the unit is the key design challenge.

The remainder of this booklet shows how the size of the unit and other design details can be incorporated to successfully control water and prevent damage caused by water infiltration. If attention is paid to a few critical details, curbless showers will meet building codes, are highly usable by most people, present few if any installation difficulties, and do not leak or present maintenance problems. It is hoped that the information provided in this booklet will increase both the quantity and quality of curbless showers available so more people may independently and safely bathe and remain in their residence of choice for as long as they wish.



Curbless showers can be used by others for **SPECIAL PURPOSES**.

Controlling Water

Two seemingly contradictory factors, a “no-threshold” entrance and adequate water control, can be provided in the same shower unit. Interrelated design elements and details are presented to help you install showers so water problems are avoided.

OVERALL SHOWER UNIT SIZE

The length and depth of the shower are critical. If the depth (from the entry to the back wall) is shallow, it is much more difficult to control water. Since the floor at the entry of the shower must be flush with the room floor, the larger the shower, the easier it is to gradually slope the shower floor to the drain and still contain water. The large size makes it easier to eliminate uneven, warped surfaces so all four wheels of a person’s shower wheelchair stay in contact with the floor. Thus, the user is able to maintain better traction and control when maneuvering into and out of the stall.

A minimum floor area in which to maneuver both outside the stall as well as inside is necessary for people using shower wheelchairs. In a narrow stall enclosed by a flexible shower curtain the bather’s small incremental movements to adjust position and reach the controls are likely to dislodge the curtain, causing water to run out onto the bathroom floor.

The *NC State Accessibility Code* and most national accessibility standards permit curbless (“roll-in”) shower interiors to be as shallow as 30 inches deep and 60 inches long, but *36 inches should be considered the minimum depth* for any curbless shower. Recently, The NC Housing Finance Agency has started to offer bonus points for more fully accessible rental units with a 36-inch by 60-inch or deeper curbless shower. Even at 36 inches, very careful attention must be paid to the floor

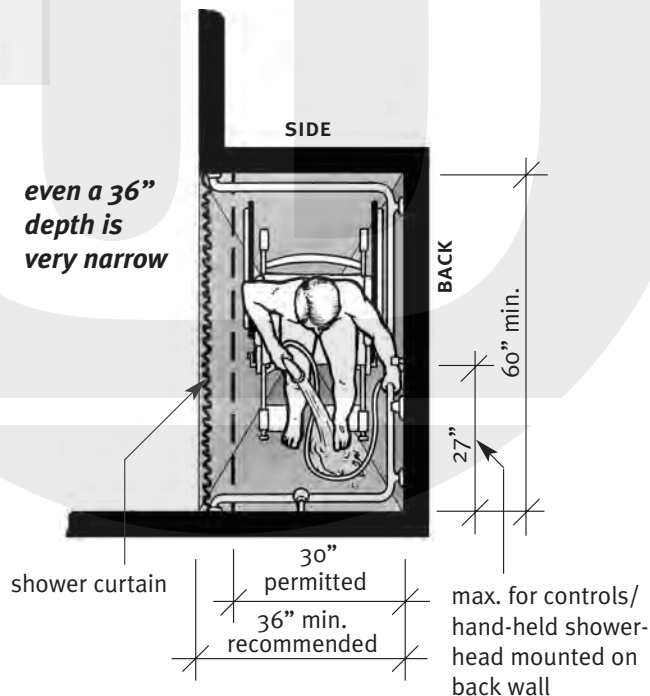

Minimum shower size

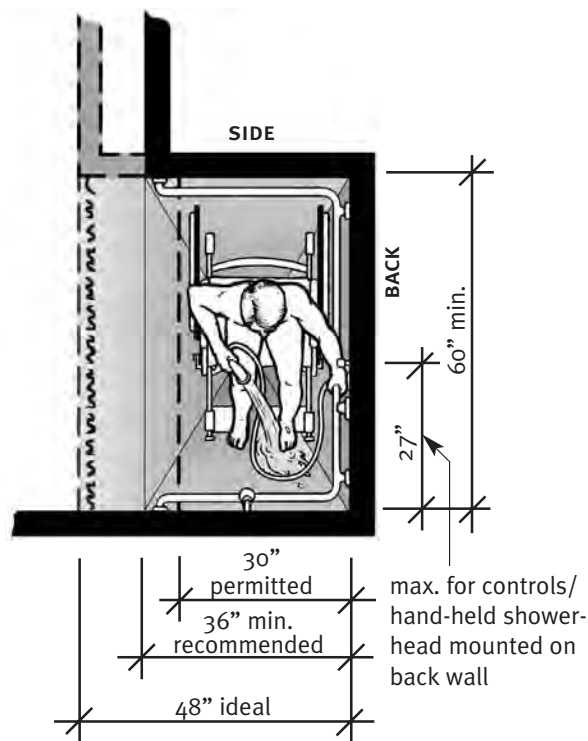

Recommended shower sizes

4

transition and other water retention strategies. A depth of 42 inches is a significant improvement and 48 inches is even better.

For most dwelling units, an adequate shower can be designed within the 36-inch to 48-inch width. However, there are people who prefer larger shower areas and others for who need assistance while bathing. A shower 5 feet by 5 feet allows enough space for a person in a shower wheelchair and an aide. Specific knowledge of a particular housing development's program will influence the number and size of curbless showers to be installed.

PLACEMENT OF FIXED AND HAND-HELD SHOWERHEADS

Showerhead type and location are important details. When considered in relation to the overall size and shape of the stall, they can dramatically aid the control of water and overspray. The preferred location of a fixed showerhead is on a sidewall since it can be aimed away from the shower entry. A hand-held

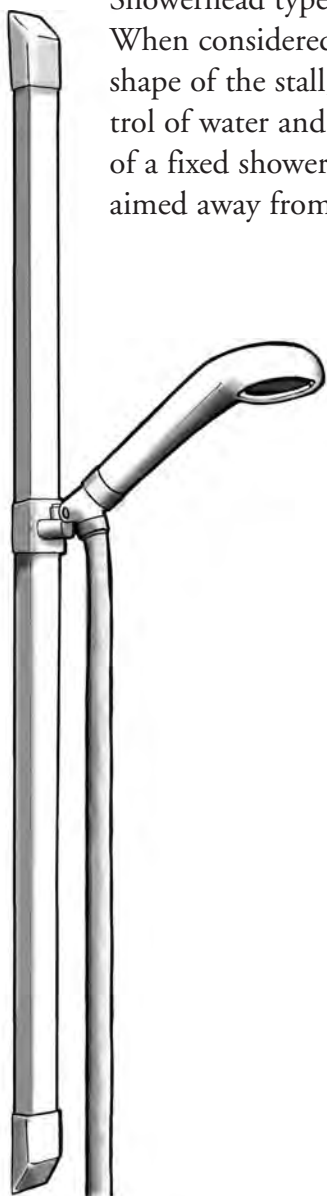

Hand-held showerhead on flexible hose

showerhead on a flexible hose, mounted on the back (or rear wall), allows a seated user to reach the showerhead and controls easily.

The *NC Accessibility Code* permits mounting a hand-held showerhead on either the back or side wall, but in very specific locations. Although the *ADA Standards for Accessible Design* and several other national accessibility guidelines permit *either* location for mounting hand-held showers, the illustrations in these documents show only the back wall location. However, hand-held showerheads may be mounted on the back and/or side walls.

One highly usable and flexible configuration is to install a fixed showerhead in the conventional location on the sidewall and add a second hand-held showerhead on the back wall with a diverter valve or additional control valve. (It may be easier and more cost-effective to plumb a second control valve rather than the diverter valve.)

NOTE: When it is critical to meet accessibility codes and standards, the hand-held showerhead must be installed so it can be adjusted easily in height, i.e. be on a slide mount.

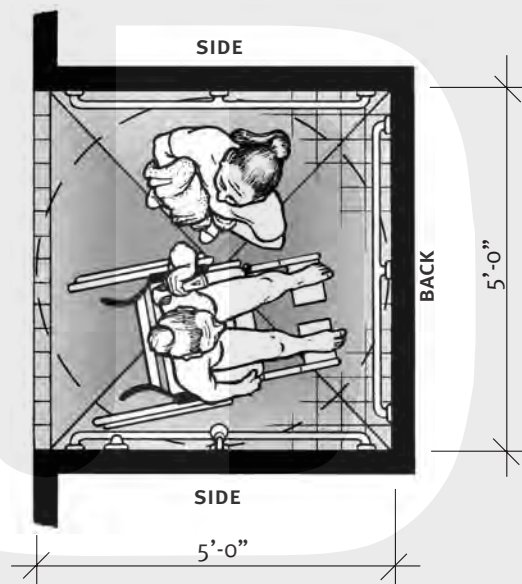

a 5' x 5' curbless shower provides space so an attendant can assist with bathing and allows a wheelchair user to turn around within the shower



Larger showers for assistance with bathing



FLUSH ENTRANCE

The *NC Accessibility Code* and most national accessibility standards prohibit any threshold or curb at the entry of curbless showers. Flush transitions between room and shower floor generally dictate that the shower be recessed into the floor of the bathroom. The shower floor must be sloped sufficiently so water will flow toward the drain and away from the entry.

5

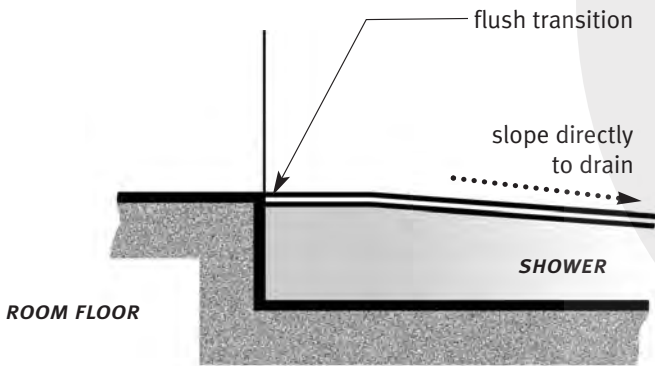

Preferred profile

works best for large showers where water containment is easier to manage

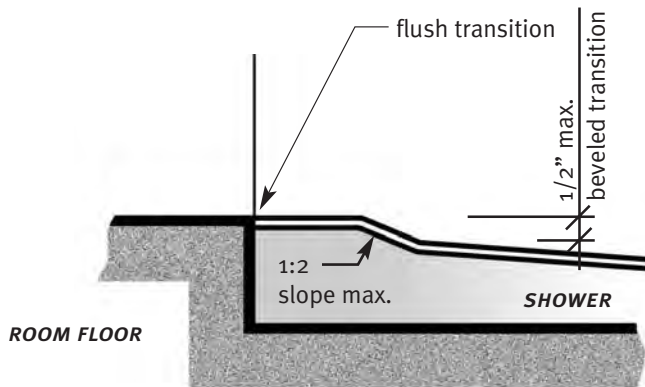

Good compromise

good detail for narrow shower where water containment is a major concern

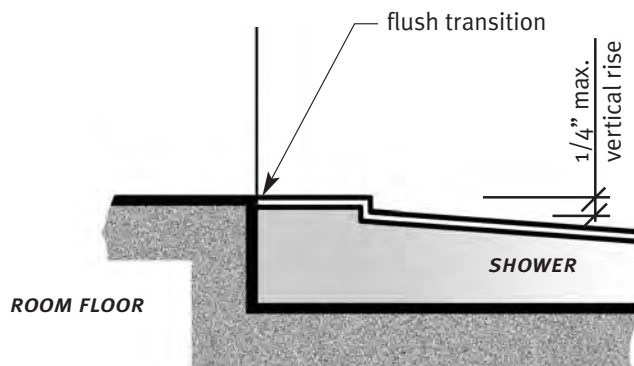

Least preferred

acceptable but some people will have difficulty rolling over any abrupt vertical transition



FLUSH TRANSITION BETWEEN ROOM FLOOR AND SHOWER

6



There are two basic methods to create a recessed shower floor. The *first*, and preferred, is to drop the floor under the shower below the adjacent floor level. The *second* is to set the shower directly on the subfloor and build up the finished floor of the room. This second method usually creates an undesirable level change at the door into the bathroom or in hallways that must be later beveled or ramped. Either approach has construction implications and, regardless of the method chosen, careful coordination is necessary between the different building trades.

A shower designed to exacting dimensions and configurations provides both water control and greater usability. A custom-built accessible shower is not necessarily more expensive than an equivalent prefabricated unit. However custom units do require more careful detailing and good supervision during construction. The following sections discuss how the floor construction (either reinforced concrete slab or wood joist framing) and the shower unit type influence “no-threshold” flush shower entrances.

••• Custom-built Showers

Custom-built units must be recessed into the floor system to create an accessible entry. The floor structure must be reengineered to accommodate a “dropped” floor.

In the case of wood framing, the subfloor is lowered and supporting joists are either dropped or resized and spaced to adequately support the floor. Additional framing members should

surround the floor recess as necessary for support. A setting or mortar bed is recommended under the entire shower area and must be sufficiently deep so it may be sloped to the drain. Usually, this requires that the floor be recessed between 1-1/2 to 2 inches and possibly even more for large showers. The top of the drain must be set below the subfloor of the room.

For concrete slab floor construction, the slab must be poured initially with a recess to accept the shower. This will change the structural dynamics of the slab under the shower and the slab must accommodate any necessary additional reinforcing and joint requirements.

In both wood frame and concrete slab construction, a *waterproof membrane* should be used to form the bottom of the shower “pan” and should extend up into the surrounding walls and out into the floor area adjacent to the shower. The installation of “two-stage” or similar drains with weep holes is recommended to allow any water adsorbed by the setting bed to seep into the drain.

Another option is to purchase a *prefabricated shower base* and apply the surrounding wall surfaces. This method does not offer the flexibility of a truly custom-built shower but it does offer the precision of a manufactured level floor transition. Attention must be paid to waterproofing and detailing as this combination of custom-built and prefabricated components lacks the integral waterproof benefits of a totally prefabricated shower unit.

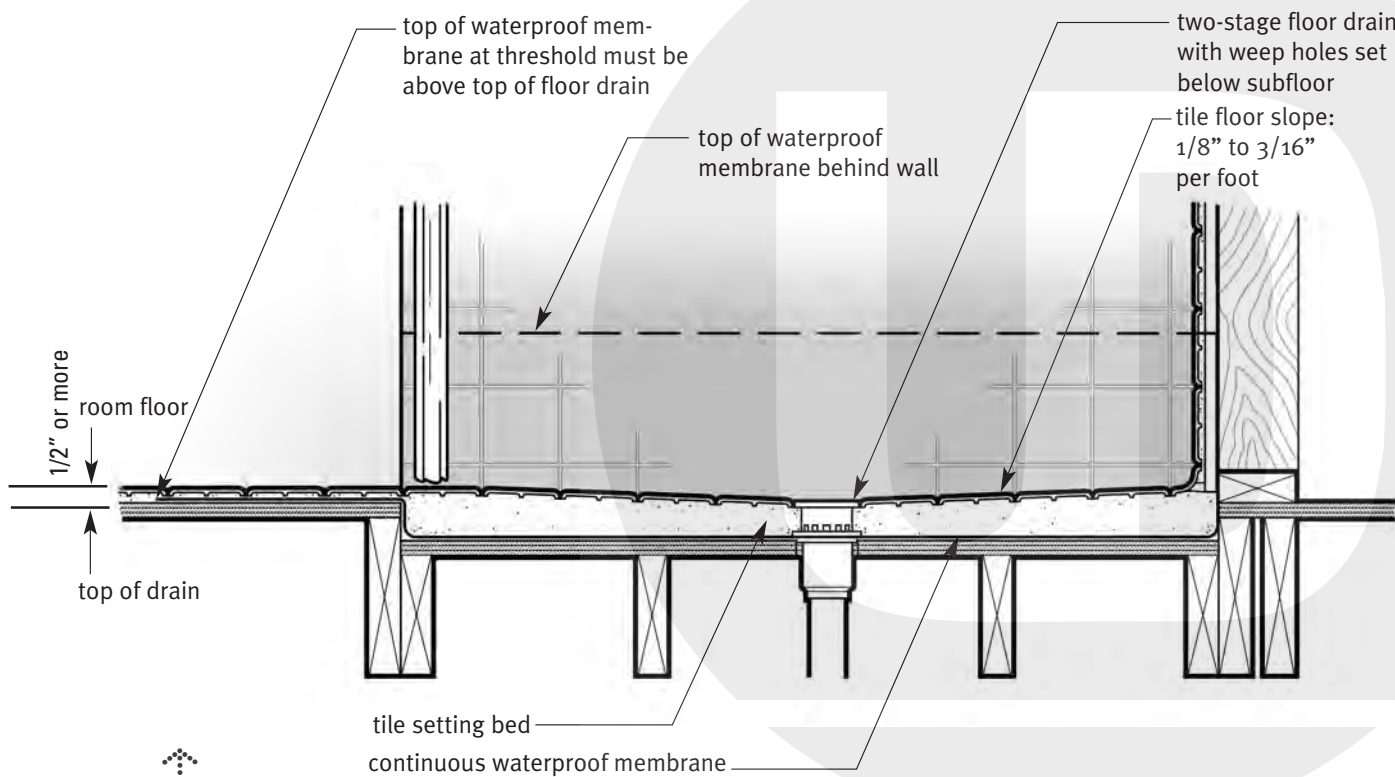

Wood frame construction

Slab on grade construction

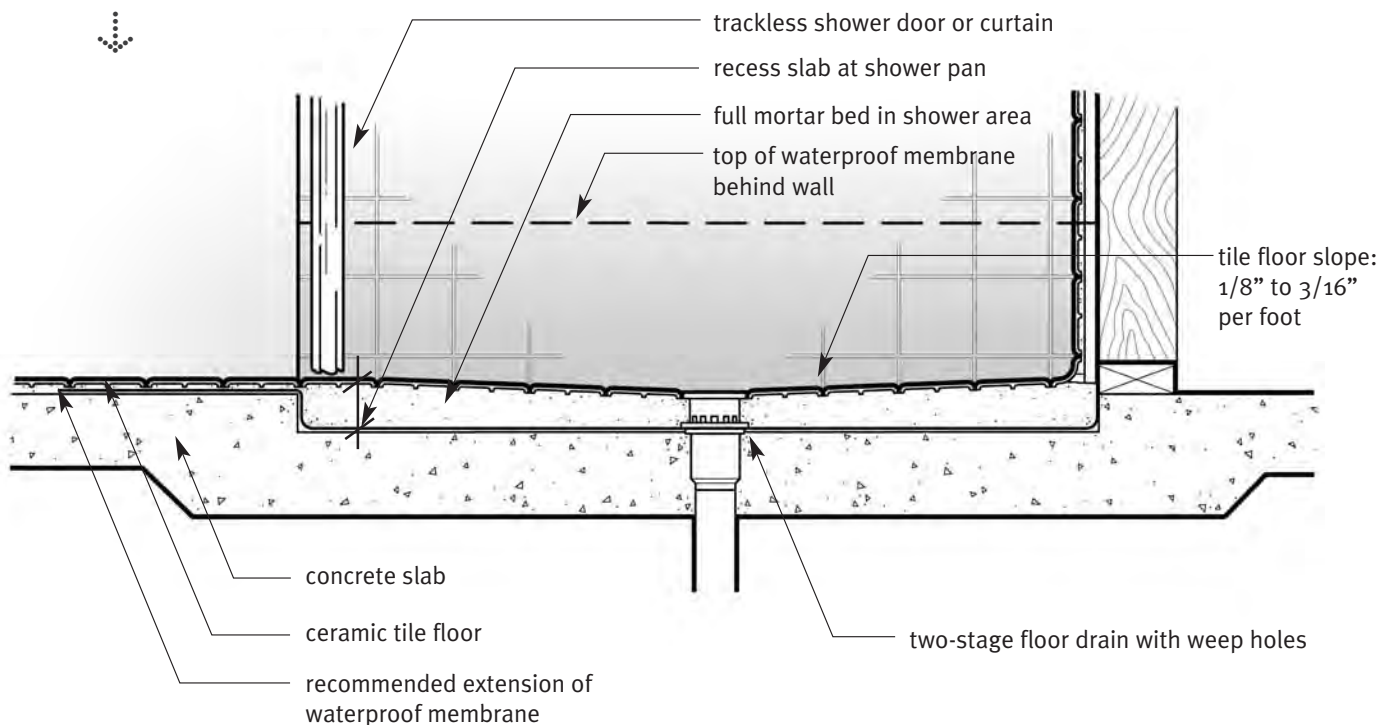

SHOWER FLOOR DETAILS AT CUSTOM-BUILT UNITS



...❖ Prefabricated Shower Units

Prefabricated curbless shower units, which generally require less on-site preparation time for installation, are now being offered by a variety of manufacturers. Since prefabricated showers are usually a single integrated unit, some of the waterproofing issues associated with custom-built showers are eliminated. However, the same water control issues at the joint between the room floor and the shower floor must be addressed.

Typically, prefabricated showers are best if recessed into the floor system in the same manner as custom-built showers. However, they need not be recessed as deeply as custom-built showers; some models, because of the design of their base, offer the option of raising the level of the room floor instead of recessing the shower.

However, care must be exercised when selecting prefabricated models advertised as “accessible.” Despite the fact that they may be set directly on the subfloor, many of these “accessible” units still have a low threshold or curb to retain water. “Roll-in” showers with even a 1/2-inch threshold should only be installed in specific retrofit situations for a particular individual or when code compliance is not required.

The base of prefabricated fixtures must be shallow to achieve a level transition between the shower floor and the room floor. Many of these

shallow units do not have the structural integrity of units with large curbs and deep floor basins. It is important to select units where the base has been “thickened” or reinforced around the entry and/or the units have been fabricated using a honeycomb cell construction that provides more overall structural integrity.

Most manufacturers recommend a bedding compound thickness based on the space beneath the shower floor to give additional rigidity and extra structural support. *When recessing prefabricated units, it is critical that the depth of the recess match exactly the requirements for the base of the specific unit.* If the recess is too shallow or too deep, it will be extremely difficult to achieve a waterproof seal between the unit and the finished floor. For units where the recess is too deep, it is possible to “shim up” the unit to match the floor level.

Raising the finished floor to create a flush transition is sometimes necessary. While this approach avoids modifying the floor joist system, it still requires the addition of another layer of subfloor or shim strips below the room’s finished flooring. Unless other portions of the finished floor are elevated, small level changes will occur and beveled thresholds must be provided.

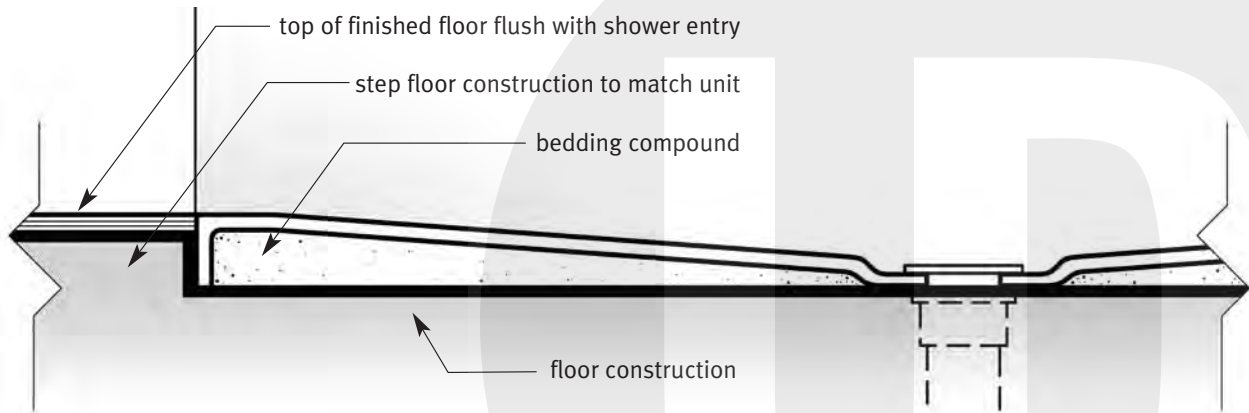

Recessed unit

Complies with most codes and standards.

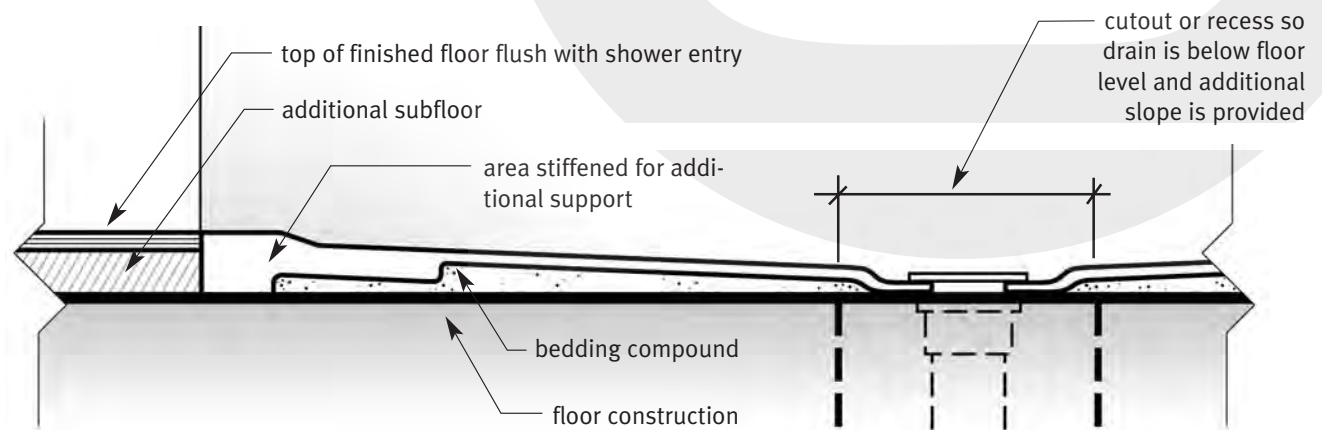

Unit with raised finished floor

Complies with most codes and standards.

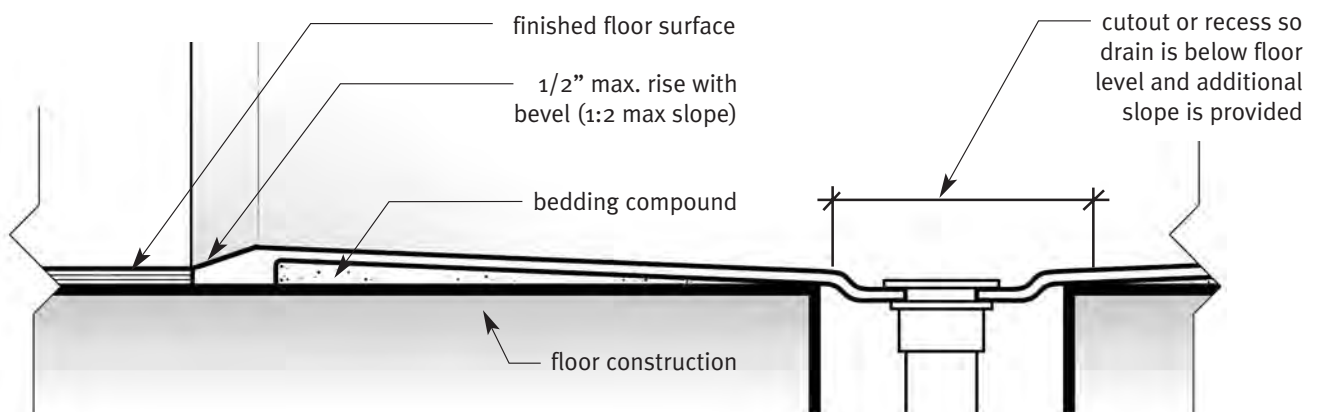

Unit set on floor (not recessed)

Complies with most codes and standards *only* if the interior of the shower area is 5 feet by 5 feet or greater.

Note: If a flush entry is not possible, in showers between 36" and 60" deep, this configuration is best used only in alterations where strict code compliance is not required. However, precautions should be taken so no threshold or curb prevents or complicates entry, maneuvering, and exit by a wheelchair user.

SHOWER FLOOR DETAILS AT PREFABRICATED UNITS

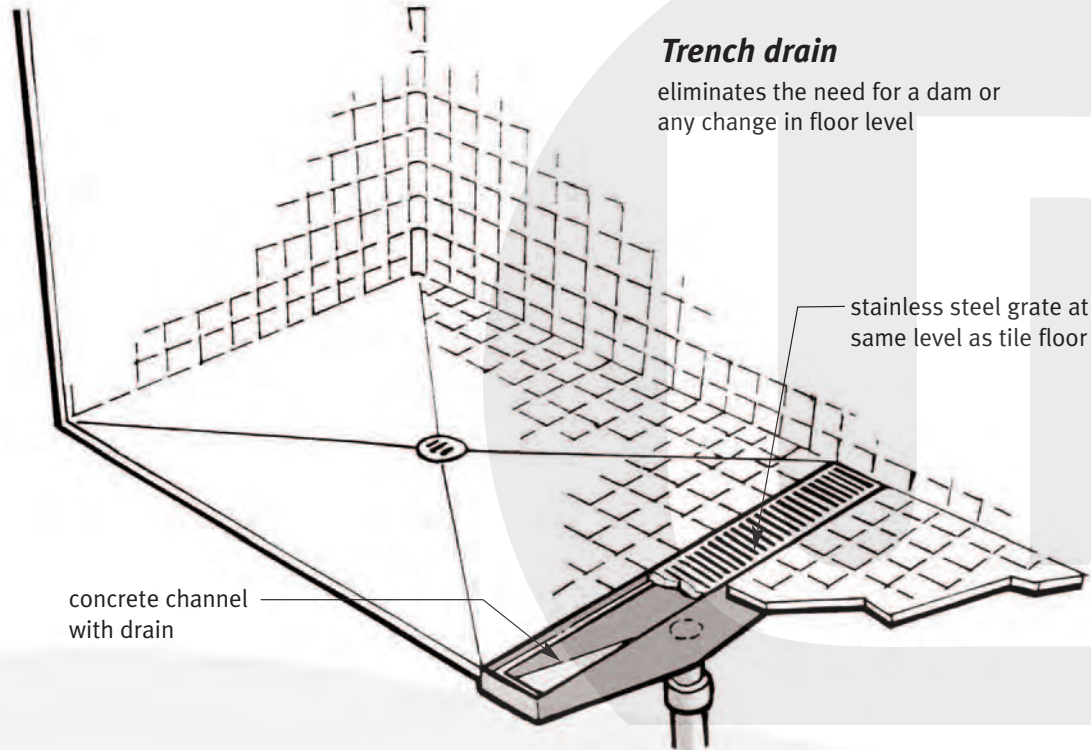

Trench drain

eliminates the need for a dam or any change in floor level

◆◆◆ **ADDITIONAL MEASURES TO CONTROL WATER**

◆◆◆ **Shower Curtains and Doors**

The methods used to enclose the shower are critical for water control. Since there is no curb, whatever method is chosen should provide a good “seal” around the unit opening. Shower curtains are economical and do not interfere with approach and maneuvering by a person using a mobility device. To effectively achieve a water seal, the curtain must be sized to fit the shower opening and be in contact with the shower floor just inside the entry. Curtains with small weights sewn into the lower seam help maintain an adequate seal.

Shower doors with a rubber flange at the bottom can provide a better seal than curtains but their size and rigidity also can restrict maneuvering. The “trackless” variety is the only viable option since there is no frame to be stepped or rolled over. Selecting doors that swing or fold out of the maneuvering space is important.

The *NC Accessibility Code* and several national accessibility standards require that the full width of the shower opening be available for entry. If doors are provided, this requires the installation of a pair of folding or swinging doors to create a full-width

entry. However, if the shower area is at least *5 feet by 5 feet*, then it has sufficient room for a person in a wheelchair to turn around. The entryway into the shower can be reduced to the size of an accessible door, i.e. 32 inches clear; however, 36 inches is easier to make turns into and is preferred.

◆◆◆ **Secondary Drains**

It is recommended that an additional drain be installed outside the shower to catch any water overflow, especially if the shower is narrow. Care must be taken to avoid an institutional look and minimize the degree and angle of floor slope inside and outside the shower.

Another option is the installation of a trench or trough drain as the primary or secondary drain along the shower opening. Water will drain into the trench before reaching the floor of the bathroom. This is a very effective solution for water control that can result in a truly flush entry. This drain type has been installed in some special use occupancies in the US for many years. Today there are a few prefabricated shower units available with this feature built in. In other countries around the world, the trench drain is a feature integrated aesthetically into the bathing area.

Flexible and Removable Dams

Flexible dams that deflect when rolled over and removable dams, which can be left in place until a flush transition is needed, are useful options. Several manufacturers offer these dams as part of their product line.

The installation of these optional features must be carefully considered with regard to who will be using the shower and how regularly. In residences or facilities where a person's needs change over time or the user of a particular shower changes periodically, temporary dams may be an appropriate solution. Flexible and removable dams also can be helpful in retrofit situations where floor space for the shower is limited, but they should always be considered backup solutions and not the primary method of water control.

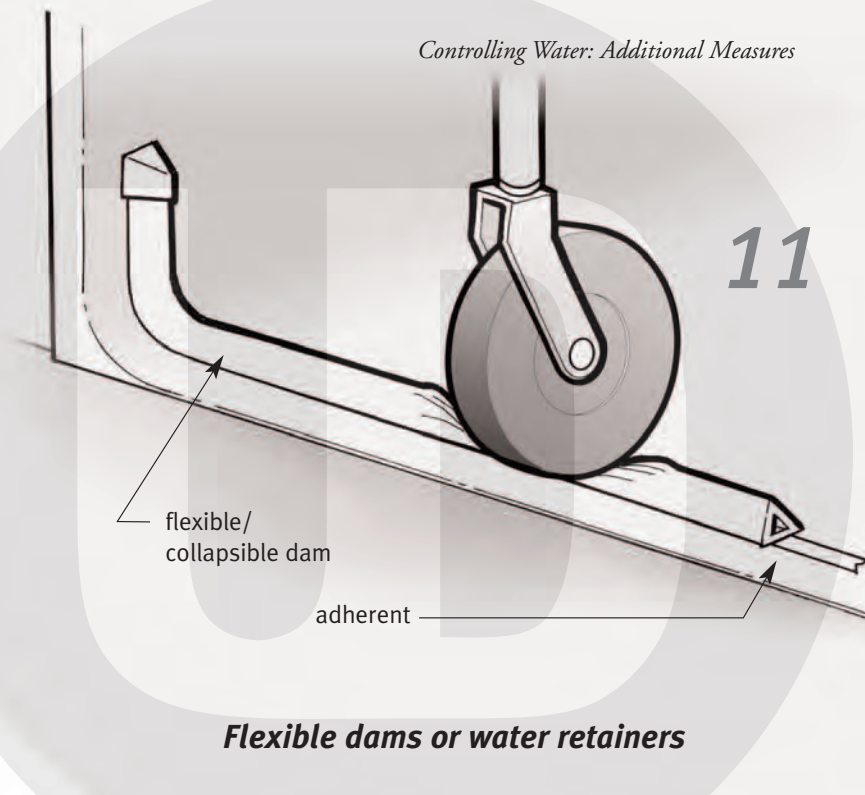

Flexible dams or water retainers

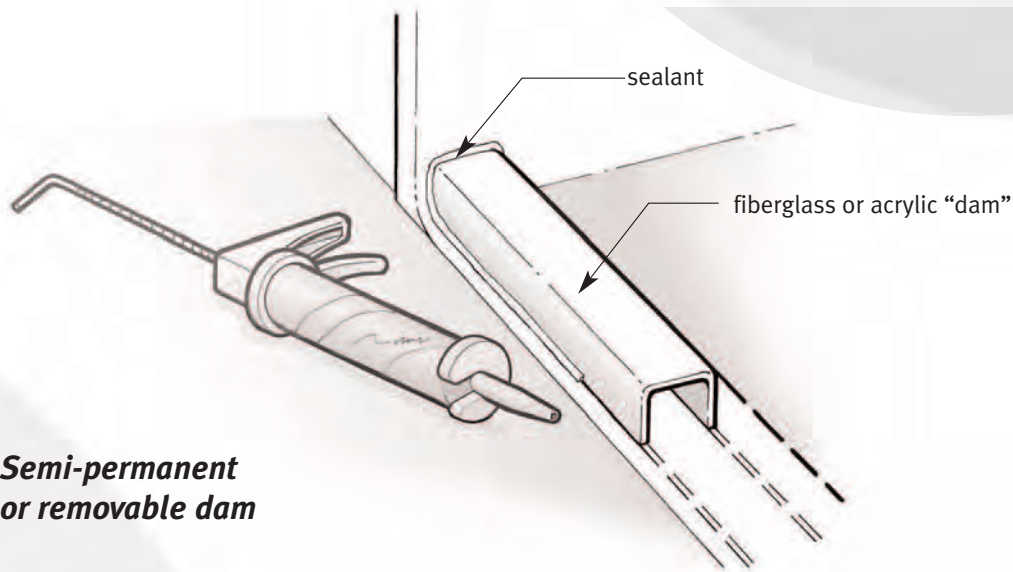

Semi-permanent or removable dam

Flexible dams are made of rubber or other synthetic materials that allow the dam to deflect when rolled over by a person in a wheelchair. Over time these will deteriorate and must be replaced. It is important to note that some people using wheelchairs may have difficulty rolling over this low dam and other people will not be able to step over or maneuver walkers around it.

Semi-permanent removable dams are higher and can be installed to retain water like a permanent integral curb. These are usually set in place and caulked with a silicon sealant and later "knocked" out when a smooth transition is needed. These

removable dams look very permanent, therefore making it important that the resident and facility manager be informed that the dam is removable.

Flexible water retainers and semi-permanent dams are not allowable when strict compliance with the *NC Accessibility Code* is required. Such showers should be installed in full compliance with the flush or no threshold entry. However, if a potential tenant does not need the curbless entry, the optional dam may be installed provided both the tenant and the manager of the property know it can be removed when requested to provide a complying flush or no threshold entry.

Reinforcing for Grab Bars & Wall-Hung Seats

The addition of grab bars in bathrooms greatly increases safety for everyone. All walls around bathing fixtures should be reinforced to support mounting grab bars. When reinforcing is provided during initial construction, grab bars can be securely mounted later at any time without removing the existing shower wall surface.

Whole wall areas of reinforcing—not just the minimums specified in many “accessibility” standards—are recommended. This enlarged area of reinforcing allows more choices for grab bar placement and at heights and configurations that best suit individual needs. This is particularly helpful for many older adults who desire vertical or angled grab bars to steady themselves when getting in to and out of bathing fixtures.

Some people prefer to sit while bathing yet would rather not sit on the floor of a bathtub. Portable or permanently-mounted shower seats are often added in curbless showers. If a seat is mounted directly to the wall it is more stable and less prone to tipping than a free-standing shower chair. Folding styles can be installed that rest against the wall when not needed. To support the seat, the person and the forces exerted when getting on and off, adequate reinforcing must be provided. Here, too, larger expanses of reinforcing are recommended so the seat can be mounted with full confidence that it will be secure. If compliance with the requirements for a Type A “fully accessible” dwelling unit as found in the *NC State Accessibility Code* or other accessibility standards is a consideration, reinforcing to adequately support a shower seat is required.

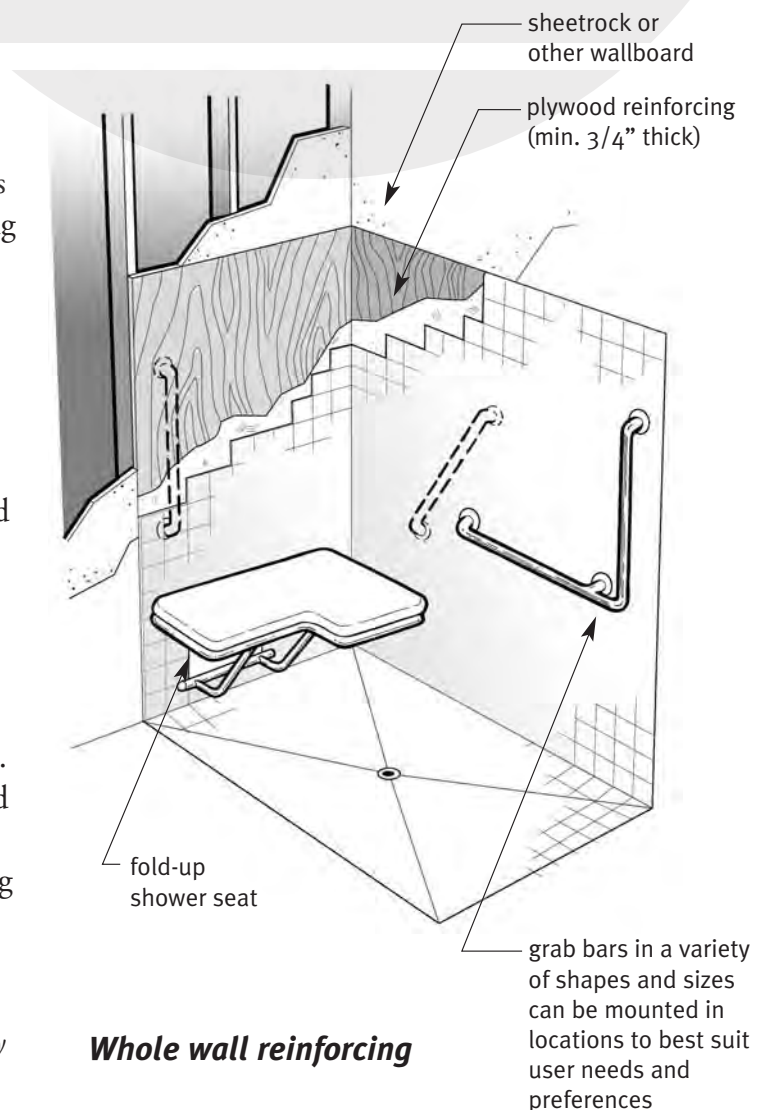

Whole wall reinforcing

For custom-built showers, plywood or other wood blocking can be “let in” between framing members or sheets of reinforcing can be applied over studs to achieve whole wall reinforcing. In contrast, providing on site reinforcing for prefabricated bathing fixtures can be a challenge. Most older and current residential prefabricated models were never engineered to have reinforcing added. The backs of many molded fixtures have uneven and angled surfaces that make it hard to evenly apply reinforcing. Additionally, there may be large voids between the fixture itself and the surrounding wall framing, making it difficult to get reinforcing to fit snugly between the shower wall and the studs.

It is best to select newer models designed with flat walls because they can accept encapsulated wood reinforcing installed at the factory. Many manufacturers will install broad panels of reinforcing on “qualified” prefabricated units if requested.

When field-installed accessories such as grab bars are mounted, it is essential to use rust-resistant stainless steel screws or fasteners. To prevent the screw from cracking the finish, create a shallow pilot hole with a larger drill bit. Always seal all fastener hardware penetrations through the shower unit surface with silicone caulk to prevent moisture from rotting the wood reinforcing.

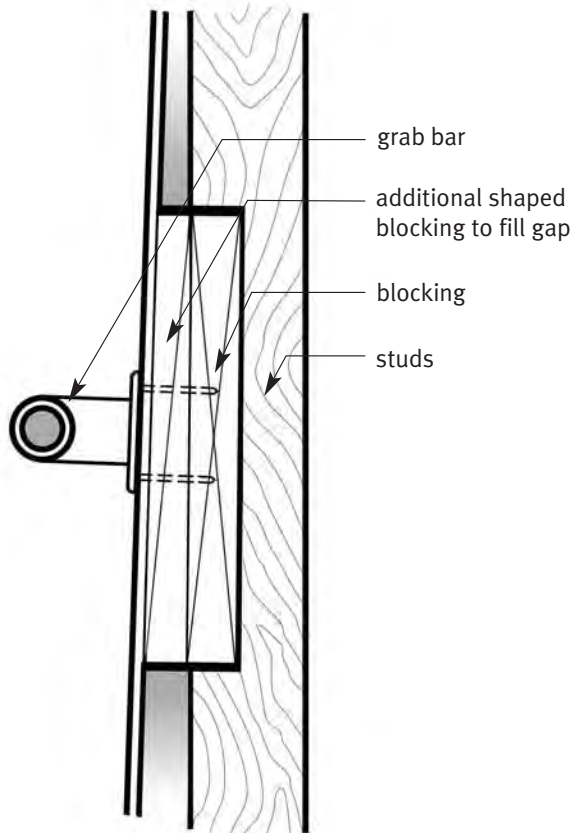

Site-installed blocking

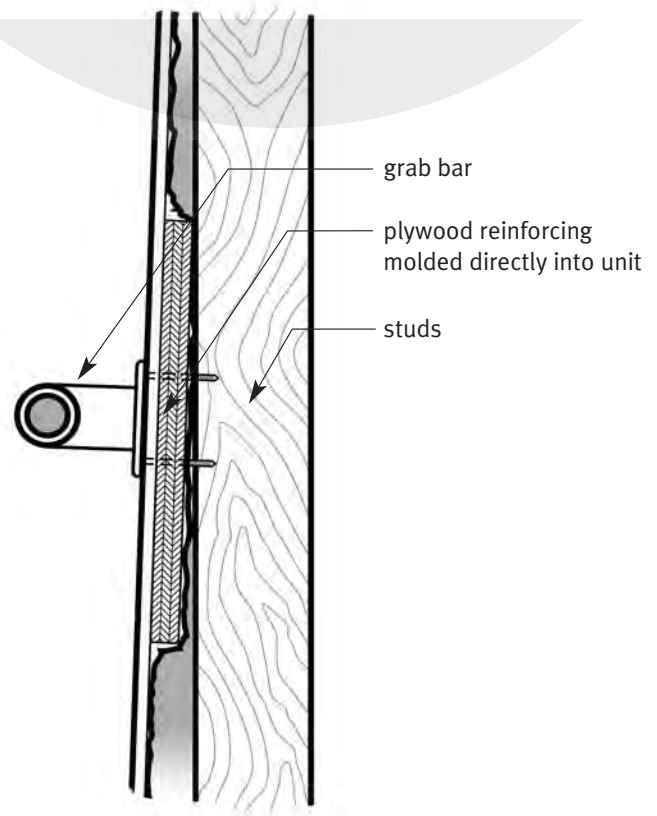

Integral or factory-installed blocking

REINFORCING FOR PREFABRICATED FIXTURES

14

diverter valve or additional control valve for hand-held shower

fixed showerhead in conventional location

weighted shower curtain or trackless shower door

whole wall reinforcing allows grab bars to be mounted vertically and in a variety of other locations

control valve offset toward shower opening (anti-scald recommended)

continuous or equivalent separate horizontal grab bars at code complying locations

flush threshold

waterproof membrane extends under finished floor

drain with weep holes

hand-held shower head on slide mount

recessed soap trays and ledges do not obstruct grab bars

60" min. long hose (72" recommended)

whole wall plywood reinforcing

waterproof membrane extends up wall

smaller-sized non-slip floor tiles for better traction

mortar setting bed

dropped subfloor

dropped and/or resized floor joists

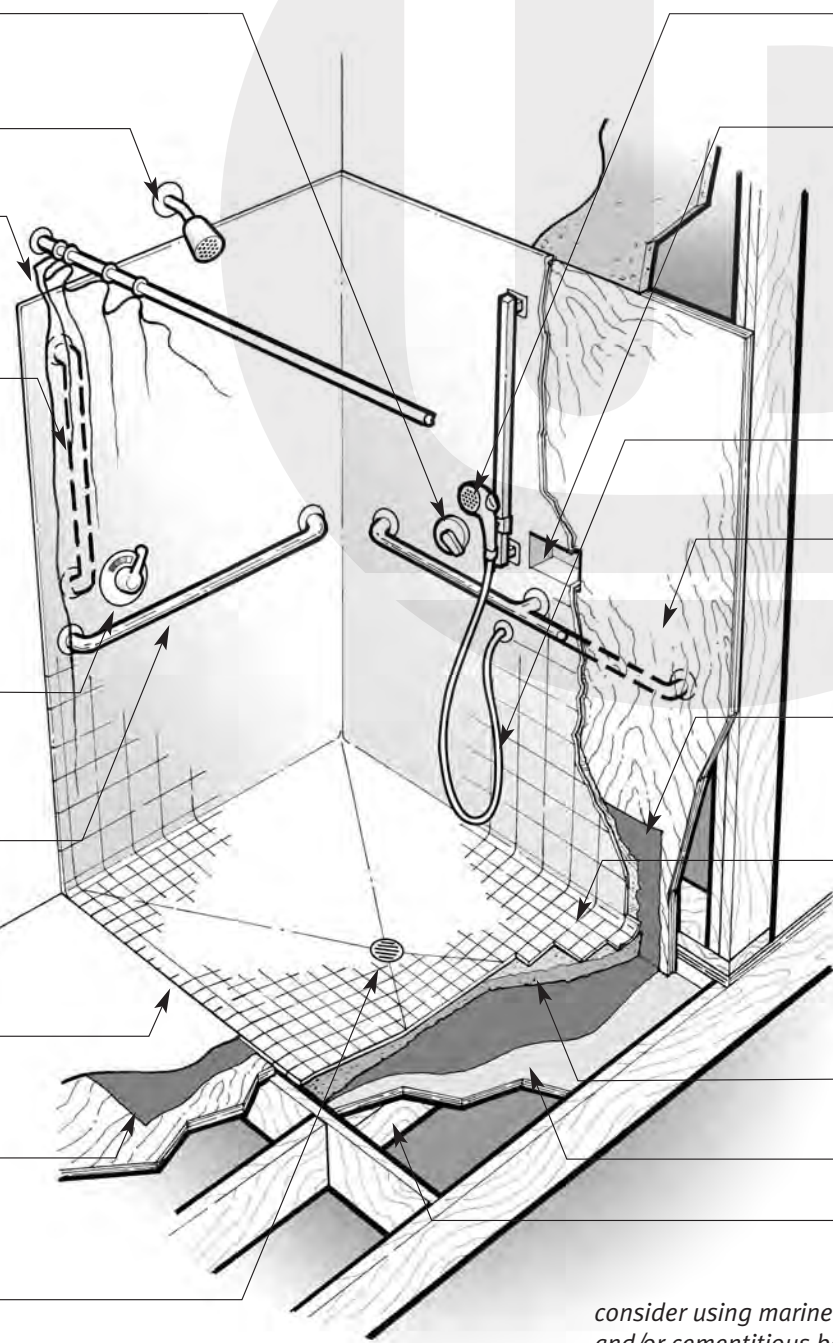

consider using marine grade plywood and/or cementitious backer board to further protect the building structure from water infiltration

FEATURES OF A CUSTOM-BUILT TILE CURBLESS SHOWER **(Wood-framed Construction)**

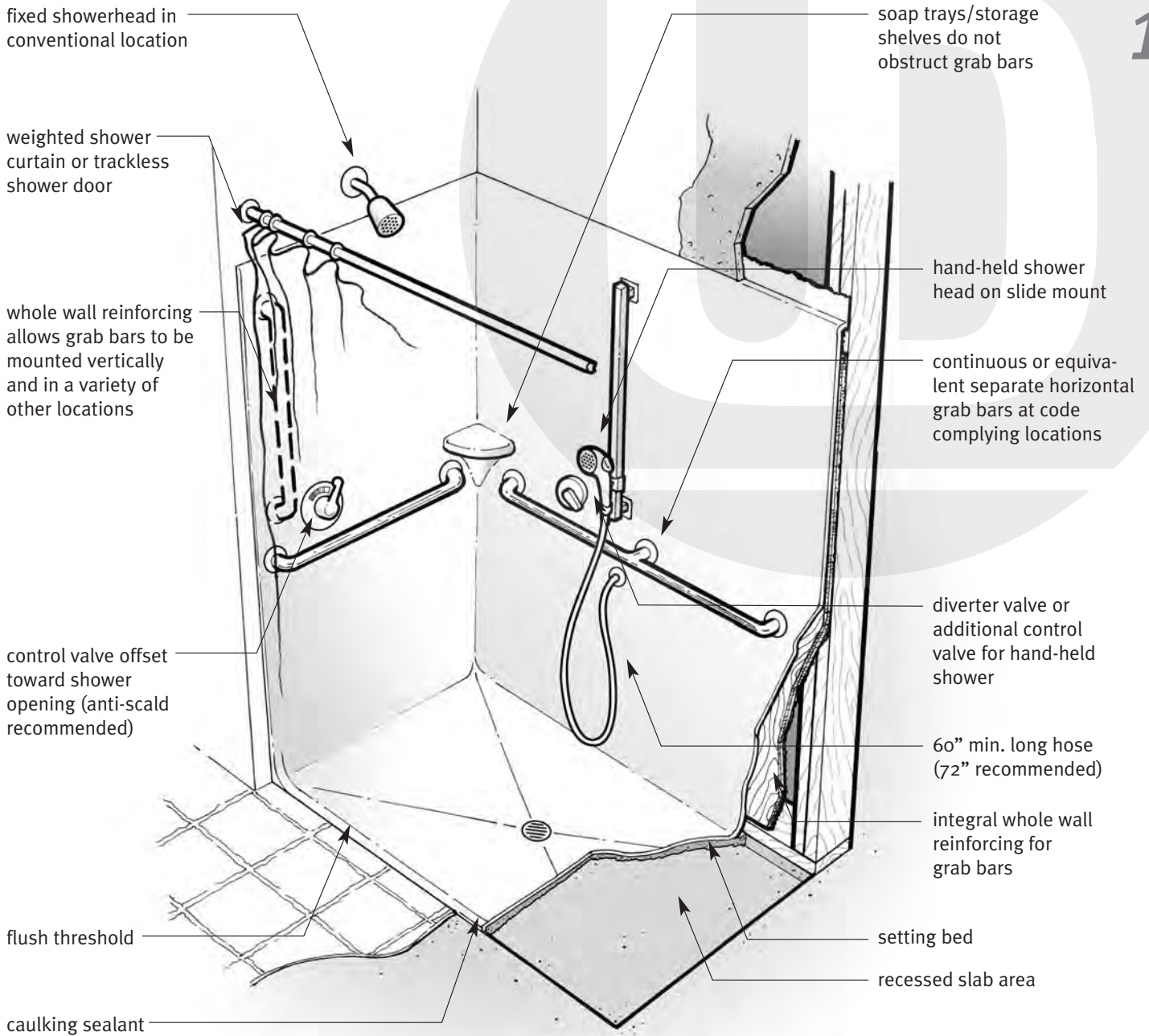

although generally not specified by most manufacturers, consider installing a waterproof membrane as shown in the custom-built unit

FEATURES OF A PREFABRICATED CURBLESS SHOWER **(Concrete Slab Construction)**

Universal Bathing Area

16

The *universal or three-way bathing area*, with several bathing fixtures combined into a single small space, is another recently developed concept. Such bathing areas are being increasingly installed due to the added safety and convenience they offer. They are truly universal in that they can be used by just about everyone.

The floor space devoted to the approach to the bathtub doubles as a curbless shower. The shower has two drains, a trench drain at the entry and a secondary drain in the center of the shower area. Note, however, that two drains are not required for this design to be successful. A soaking tub is added, along with a bench seat that runs along the back of the shower and extends behind the head of the bathtub.

Some of the possible bathing options include:

- standing to shower
- sitting in a portable chair or in a shower wheelchair
- transferring onto the seat at the back of the tub before entering the water
- soaking in the tub
- using a portable shower chair in the tub
- sitting on the shower bench

When designing a *universal bathing area* and where strict code compliance is required, the shower bench to the side of the bathtub should be removable or lift up so a person using a wheelchair can position themselves close to the head of the tub to make a safe transfer onto the seat. Reinforcing should be included in all walls in the bathing area so grab bars can be mounted securely, as shown in the *NC State Accessibility Code* and national accessibility standards. Whole wall reinforcing is preferred so it is possible to mount grab bars where they offer the greatest security for the user.

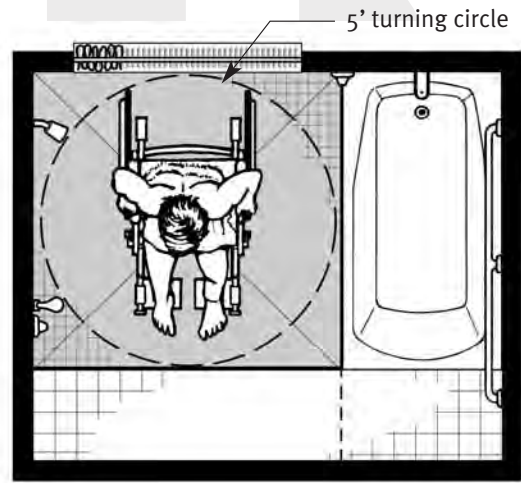

Curbless shower

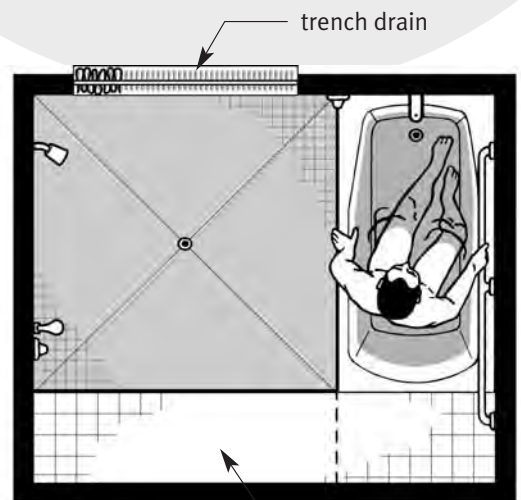

Soaking tub

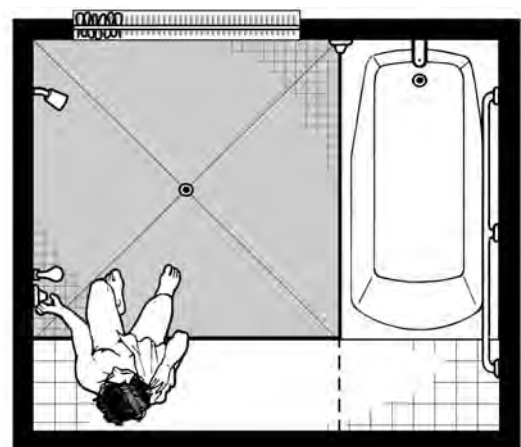

Shower bench

5' x 5' curbless shower
doubles as the clear floor
area for approach to tub
and shower seat

trench drain at
flush entrance

vertical bar for additional
security when getting in
and out of tub

fixed showerhead

control valve offset
to outside of tub

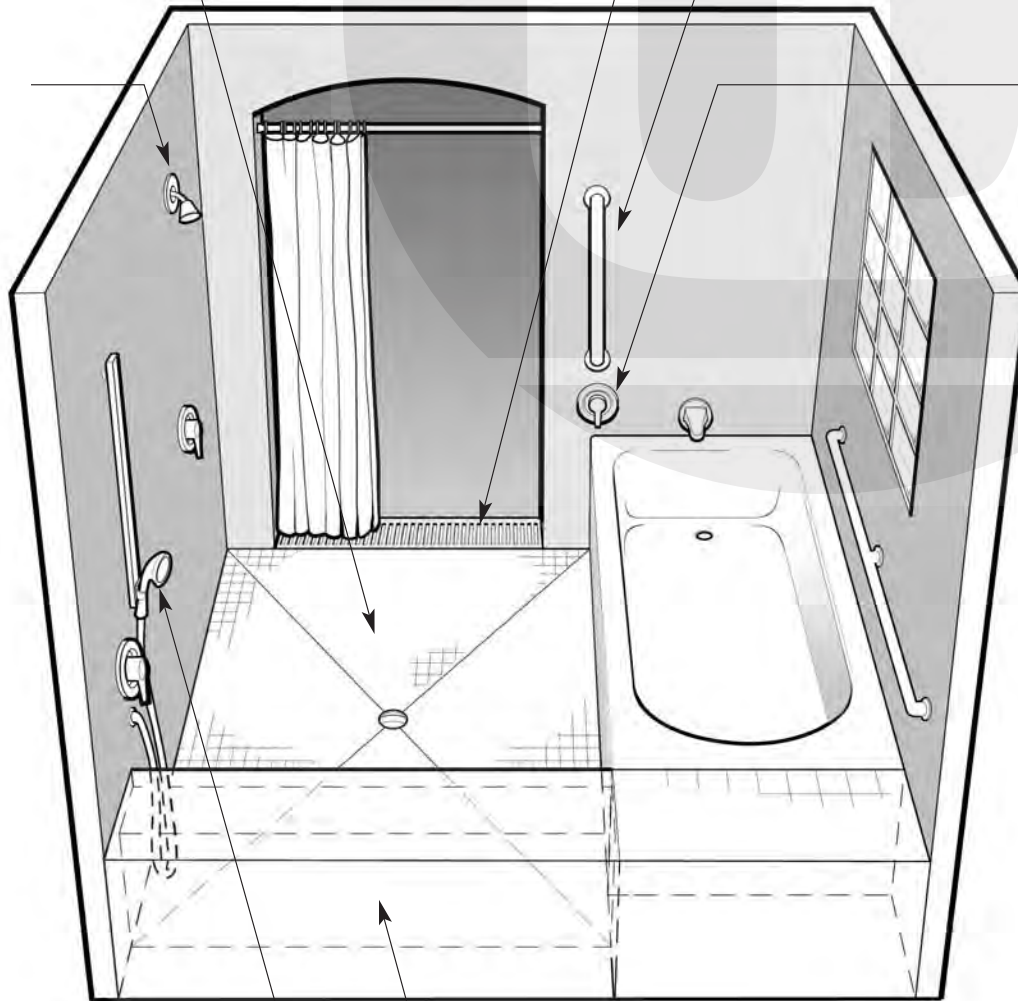

hand-held shower
head can be used
while sitting on bench
or standing in shower

open space under bench gives
wheelchair user more maneu-
vering area, making it easier to
approach and use controls

UNIVERSAL OR THREE-WAY BATHING AREA
combines fixed features in a small space to offer users a variety of choices

Molded reinforced fiberglass curbless shower stalls are available from a wide variety of companies. Units are available with a range of options and sizes. Most companies offer the 36-inch by 60-inch size. Some have larger units such as the 48-inch by 60-inch and the 60-inch by 60-inch. All units must be carefully selected and installed so neither curbs nor thresholds interfere with a smooth, level transition.

This list is provided for information purposes and is only a sampling of available companies. Neither the authors of this booklet nor NC State University endorse these companies.

Aqua Bath Company, Inc.
921 Cherokee Ave.
Nashville, TN 37207
Phone: 1-800-232-2284
www.aquabath.com
aquabath@bellsouth.net

Best Bath Systems
4545 Enterprise
Boise, Idaho 83705
Phone: 1-800-727-9907
www.best-bath.com
sales@best-bath.com

Aqua Glass Corporation
320 Industrial Park Drive
Adamsville, TN 38310
Phone: 1-800-435-7875
www.aquaglass.com
techservice@aquaglass.com

Comfort Designs
P.O. Box 34279
Richmond, Virginia 23234
Phone: 1-800-801-2820
comfortdesigns@aol.com

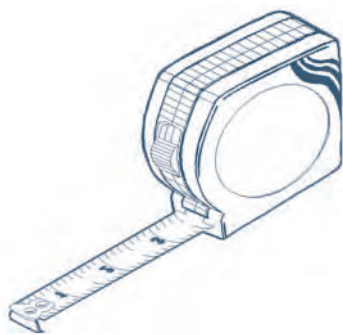

Curbless Showers

AN INSTALLATION GUIDE

Disclaimer:

The statements and conclusions contained in this booklet are those of the Center for Universal Design. This document is intended to serve as a guide to design professionals and those involved in specifying and installing bathing fixtures as the North Carolina Division of Vocational Rehabilitation Services promotes the concept of increased independence in housing for all the people it serves. The Center for Universal Design has made every effort to verify the accuracy and appropriateness of this booklet's content so it may be regarded as an accurate resource document. Yet, the information is advisory and the guidance provided is not legally binding. Readers are advised to refer to specific codes, regulations, and requirements within their jurisdictions and to remember that no guarantee is offered or implied for the completeness of the information provided.

2,500 copies of this booklet were printed at a cost of \$2449 or \$.98 per copy (6/2003)

THE CENTER FOR **UNIVERSAL DESIGN**

NC STATE UNIVERSITY College of Design

Box 8613

Raleigh, NC 27695-8613

919.515.3082 (V/TTY)

919.515.7330 (FAX)

800.647.6777 (V/TTY Info Request Line)

cud@ncsu.edu

<http://www.design.ncsu.edu/cud>

